

218
BEFORE THE HON'BLE NATIONAL GREEN TRIBUNAL
PRINCIPAL BENCH, NEW DELHI
APPEAL NO. 57/2025

Devesh Kumar Verma

Appellant

Vs.

Environment, Forest and Climate Change,
Department (DOEFCC), Govt. of U.P. &Ors.

Respondents

Index

| S. No | Particulars | Page No. |
|--------------|--|-----------------|
| 1. | Reply on behalf of CPCB respondent no. 6, Central Pollution Control Board (CPCB) in compliance to Hon'ble NGT order dated 04.09.2025 in Appeal No. 57/2025. | |
| 2. | Annexure I- A copy of Hon'ble NGT order dated 04.09.2025 in Appeal No. 57/2025. | |
| 3. | Annexure II- A copy of notification dated 16.03.2012. | |
| 4. | Annexure III- A copy of Guidelines for (i) Sitting of rice shellers /mills; (ii) handling and storage of rice husk and (iii) handling, storage and disposal of ash generated in boiler using rice husk as fuel” | |



Filed by Advocate Suman Arora
On behalf of Central Pollution Control Board

Place: Delhi

Dated: 18.11.2025

**BEFORE THE HON'BLE NATIONAL GREEN TRIBUNAL
PRINCIPAL BENCH, NEW DELHI
APPEAL NO. 57/2025**

Devesh Kumar Verma

Appellant

Vs.

Environment, Forest and Climate Change,
Department (DOEFCC), Govt. of U.P. & Ors.

Respondents

**REPLY ON BEHALF OF CENTRAL POLLUTION CONTROL BOARD
(CPCB), RESPONDENT NO. 6**

Preliminary Submissions:

1. That the Hon'ble National Green Tribunal, Principal Bench, New Delhi (hereinafter referred to as the "Hon'ble NGT") vide Order dated 04.09.2025 in Appeal No. 57/2025 has sought the reply of Central Pollution Control Board (hereinafter referred to as the "CPCB") in the instant matter. Thereby the reply is made in the succeeding paragraphs. A copy of the Hon'ble NGT Order dated 04.09.2025 is annexed as **Annexure - I**.
2. That through the present Appeal, the Appellant is challenging the order dated 23.07.2025 passed by the Special Secretary, Environment, Forest and Climate Change Department, Government of Uttar Pradesh, (hereafter referred to as Respondent No. 1). By the impugned order, the Respondent No. 1 set aside the orders dated 30.03.2024 and 04.02.2025 issued by the Regional Officer and Environmental Engineer of Uttar Pradesh Pollution Control Board (hereinafter referred to as the "UPPCB") respectively, relating to a parboiled rice mill i.e M/s Shiv Shakti Traders operating in violation of environmental norms and siting criteria.



3. That at the outset, the Answering Respondent denies all claims, contentions, allegations and averments against the Answering Respondent i.e. CPCB in the above Appeal contrary to anything stated or submitted in expressly in this reply. Nothing in the Appeal may be deemed to have been accepted or admitted by the Answering Respondent for want of a specific denial or on the ground of non-traverse, save any averment which has been expressly admitted hereinafter.
4. That CPCB is constituted under the Water (Prevention and Control of Pollution) Act, 1974 (hereinafter referred to as "the Water Act, 1974"). It performs the functions under the Water Act, 1974, the Air (Prevention and Control of Pollution) Act, 1981 (hereinafter referred to as "the Air Act, 1981"), and the Environment (Protection) Act, 1986.
5. That the State Pollution Control Boards/Pollution Control Committees (hereinafter referred to as "SPCBs/PCCs") have been constituted in States / Union Territories under the Water Act, 1974 and the Air Act, 1981 and are empowered to perform the functions and implement the provisions of these Acts in respect of territories falling in their respective territorial jurisdiction.
6. That, as per the modified direction dated 07.03.2016 issued by CPCB under section 18(1)(b) of the Water Act, 1974 and the Air Act, 1981 to all the SPCBs/PCCs regarding harmonization of classification of Industrial Sectors under Red/Orange/Green/White " Par Boiled Rice Mills" are categorized under "Orange" Category. Recently, during February, 2025, CPCB has revised the methodology for classification of sectors. As per the revised classification, "Par Boiled Rice Mills (with soaking and steam/drier)" are categorized under "Orange" category and "Raw rice mill (Without soaking and steam/drier)/hullers)" are categorized under "Green" category. The said revised classification 2025 has been circulated to all the SPCBs/PCCs for



implementation vide CPCB direction dated 12.02.2025 under Section 18(1)(b) of the Water Act, 1974 and the Air Act, 1981. The 'Orange/Green' category of industrial sectors are required to obtain Consent to Establish (hereinafter referred to as 'CTE') and Consent to Operate (hereinafter referred to as 'CTO') from the concerned SPCB/PCC. The Par Boiled Rice Mills should operate only after obtaining prior CTE and CTO from the concerned SPCB/PCC and shall comply with the conditions laid down in CTE and CTO.

7. That to address the environmental issues associated with Rice Mills, CPCB has issued Comprehensive Industry Document (COINDS) "Guidelines for (i) Siting of rice shellers/mills; (ii) Handling and storage of rice husk; and (iii) Handling, storage and disposal of ash generated in boiler using rice husk as fuel". The said document stipulates the production processes in Rice Mills, current practices adopted for handling & storage of rice husk, storage & disposal of rice husk fired boiler ash and Siting Criteria for new rice mills. The said document also stipulates the sources of Fugitive emissions and its control system adopted and type of Air Pollution Control Devices installed in rice mills. The said document also outlined the possible uses/utilization of Rice husk ash. A copy of the said CPCB document is annexed as **Annexure-II**.
8. That the Ministry of Environment, Forest and Climate Change (MoEF&CC) has notified the Environmental Standards for Grain Processing, Flour Mills, Paddy Processing, Pulse Making or Grinding Mills under the provisions of the Environment (Protection) Rules, 1986 vide G.S.R. 152(E), dated 2nd March, 2012, prescribing emission and effluent discharge norms for such units. A true copy of the said notification is annexed as **Annexure-III**.



PARA WISE REPLY:

9. That the averments made in Para 1 of the Appeal are regarding filing of the present appeal under statutory provisions before this Hon'ble Tribunal and hence, require no comments from this Answering Respondent.
10. That the averments made in the Para 2 of the Appeal are regarding the impugned order dated 23.07.2025 passed by the Special Secretary, Environment, Forest and Climate Change Department, Government of Uttar Pradesh. The matter does not refer to this Answering Respondent and hence, need no comments from this Answering Respondent.
11. That the averments made in Para 3 of the Appeal are regarding alleged operation of parboiled rice mill in violation of environmental laws in the vicinity of Appellant's house causing pollution in the area. In reply, it is humbly submitted that the issuance of Consent to Establish and Consent to Operate comes under the purview of SPCB/PCC, hence, may be appropriately replied by UPPCB.
12. That the averments made in Para 4 & 5 of the appeal are regarding the various statutory provisions for the filing of the present appeal, and hence need no reply from this answering respondent being matter of record.
13. That the averments made in Para 6 of the appeal are regarding reference of siting criteria of the rice mill under CPCB Comprehensive Industrial Documents (COINDS). In reply, it is humbly submitted that CPCB has issued "Guidelines for (i) Siting of rice shellers/mills; (ii) Handling and storage of rice husk; and (iii) Handling, storage and disposal of ash generated in boiler using rice husk as fuel" under the Comprehensive Industry Document Series (COINDS), wherein siting norms are mentioned. The said document is uploaded on CPCB website at weblink <https://cpcb.nic.in/openpdffile.php?id=UHVibGljYXRpb25GaWxlLzI>

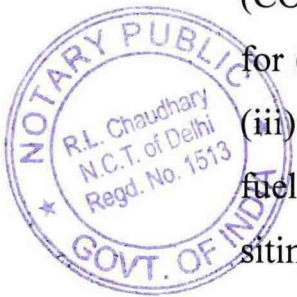

0XzE0NTY5ODU1NjBfUHVibGljYXRpb25fNTE5X0d1aWRlbGluZVJlcG9y
dC5wZGY=

14. That the averments made in Para 7 of the appeal are regarding reference of UPPCB's letter dated 19.07.2023 seeking report from Zila Basic Siksha Adhikari(BSA) Ghazipur and UPPCB's letter dated 30.03.2024 regarding year of establishment of the Govt. Composite School and census village near the vicinity of rice mill. The averments do not refer to this Answering Respondent and hence, need no comments from this Answering Respondent.
15. That the averments made in Para 8 of the Appeal are regarding Closure Order issued by the Sub-Divisional Magistrate (SDM), Tehsil Muhamdabad, District Ghazipur, Uttar Pradesh, to M/s Shiv Shakti Traders, Respondent no. 5. The same may be appropriately addressed by the concerned authorities and hence, need no comments from this Answering Respondent.
16. That the averments made in Para 9 of the appeal are regarding the inspection and observations of a three-member committee constituted by the Chairman, Uttar Pradesh Pollution Control Board. vide Office Order dated 02.05.2024 and about the findings of said committee report and hence, need no comments from this Answering Respondent.
17. That the averments made in Para 10 of the appeal are regarding general description of rice milling processes and associated environmental aspects, including generation of process wastewater, particulate emissions, and solid waste such as rice husk and rice husk ash. In this regard, it is humbly submitted that the submission made in para no. 7 & 8 are re-iterated and not repeated herein for the sake of brevity.

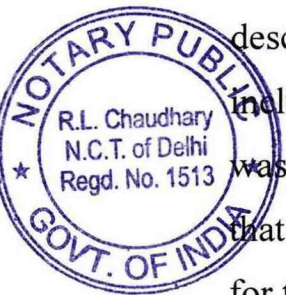

18. That the averments made in Para 11 of the appeal are regarding Show Cause Notice under Section 31A of the Air (Prevention and Control of Pollution) Act, 1981 dated 30.03.2024 followed by a Closure Order dated 04.02.2025 issued by UPPCB to the unit on account of environmental violations. It is a matter of record and hence, need no comments from this Answering Respondent.
19. That the averments made in Para 12 of the appeal refer to the proceedings before the Hon'ble Allahabad High Court in Public Interest Litigation (PIL) No. 2297 of 2023, titled Devesh Kumar Verma vs. State of Uttar Pradesh and Ors. It is a matter of record and hence, need no comments from this Answering Respondent.
20. That the averments made in Para 13 of the Appeal refer to the order dated 08.05.2024 passed by the Hon'ble National Green Tribunal (PB) in Original Application No. 510/2024; *Devesh Kumar Verma vs. Union of India & Others*. It is a matter of record and hence, need no comments from this Answering Respondent.
21. That the averments made in Para 14 of the Appeal refer to the Order dated 23.02.2024 passed by the Hon'ble Allahabad High Court in the matter, WRIT-C No. 5638 of 2024 titled, *M/s Shiv Shakti Traders and Another Vs. State of U.P. and five others*. It is a matter of record and hence, need no comments from this Answering Respondent.
22. That the averments made in para 15 of the Appeal are regarding the reply/representation made by the respondent no.4 and 5 to the Regional Officer, Varanasi, UPPCB, on 01.03.2024. It is a matter of record and hence, need no comments from this Answering Respondent.

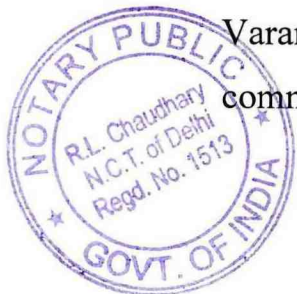

23. That the averments made in para 16 of the Appeal are regarding the Closure Order issued by UPPCB under Section 31-A of the Air (Prevention and Control of Pollution) Act, 1981 to the unit. It is a matter of record and hence, need no comments from this Answering Respondent.
24. That the averments made in Para 17 of the Appeal are regarding complaints received from local residents and the Principal of the Government Composite School regarding the pollution allegedly caused by M/s Shiv Shakti Traders, Respondent no. 4 and a subsequent Joint Committee Report. The same may be appropriately addressed by UPPCB and hence, need no comments from this Answering Respondent.
25. That the averments made in Para 18 of the appeal pertain to the findings of the Joint Inspection Team and hence may, be appropriately addressed by UPPCB.
26. That the averments made in Para 19 of the appeal are regarding recommendation/communication by the Regional Officer, UPPCB, Varanasi, dated 27.05.2023 to the Chief Environmental Officer, UPPCB, Lucknow for action under Section 31A of the Air Act, 1981 and hence may, be appropriately addressed by UPPCB.
27. That the averments made in Paras 20 to 25 of the Appeal are regarding SDM inquiry reports, grant and revocation of CTO/CTE, Constitution of 4-member Joint Committee, inspections by joint committee, etc. That the same may be appropriately addressed by concerned authorities and need no comments from this Answering Respondent.
28. That the averments made in Para 26 of the Appeal refer to the Allahabad High Court order dated 01.04.2025 in WRIT-C No. 5638 of 2024 titled, *M/s Shiv*

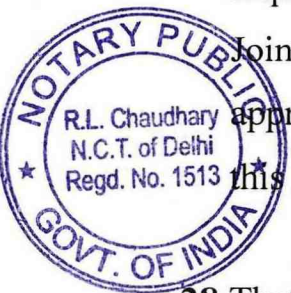

Shakti Traders and Another Vs. State of U.P. and five others, which is a matter of record and hence, need no comments from this Answering Respondent.

29. That the averments made in Paras 27-28 of the Appeal make reference to the Articles of the Constitution of India and hence, need no comments from this Answering Respondent, being matter of record.

30. That the averments made in Paras 29 and 30 of the Appeal are regarding reference of various reports of local authorities and UPPCB establishing that the unit is operational in densely populated area without obtaining CTE and CTO and causing environmental pollution. In reply it is humbly submitted that the reply in preceding paras may be read here for the true appreciation of the matter so far as the role of the Answering Respondent, CPCB is concerned. The same are not being repeated here for the sake of brevity and to avoid repetition.

31. That the averments made in para 31 are regarding the provisions of limitation. Being legal in nature, the answering respondent CPCB has no comment to offer in this regard.

32. That the averments made in para 32 are prayers made by the appellant to this Hon'ble Tribunal and as such need no comments from this Answering Respondent, CPCB.

REPLY TO THE GROUNDS:

33. In view of the reply submitted above, it is prayed by the Answering Respondent, CPCB that the contents of the preceding paras may also be considered here against the submission to Grounds of Appeal. The same are not being repeated for the sake of brevity and to avoid repetition.



34. That, in the light of the above submissions, it is respectfully submitted that this Answering Respondent, i.e., CPCB, shall abide by any order(s) or direction(s) passed by this Hon'ble NGT in the instant Appeal.



(Anamika Sagar)
Scientist 'E'

Central Pollution Control Board

18.11.2025



Central Pollution Control Board
Ministry of Environment, Forest and Climate Change
Government of India
New Delhi

**BEFORE THE HON'BLE NATIONAL GREEN TRIBUNAL
PRINCIPAL BENCH, NEW DELHI
APPEAL NO. 57/2025**

Devesh Kumar Verma

Appellant

Vs.

Environment, Forest and Climate Change,
Department (DOEFCC), Govt. of U.P. & Ors.

Respondents

AFFIDAVIT

I, **Anamika Sagar** working as Scientist 'E' in Central Pollution Control Board, Parivesh Bhawan, East Arjun Nagar, Delhi, the Respondent No. 6 in the above matter, do hereby solemnly affirm, declare on oath and state as under:-

1. That I, the deponent herein is well conversant with the facts and circumstances of the present case on the basis of the information derived from the official records, and hence, I am competent to verify, sign and swear this affidavit on behalf of the Respondent CPCB.
2. That the accompanying reply may be read part and parcel of the present affidavit.
3. That the accompanying reply has been drafted and filed under my instructions and authority and the contents thereof are true and correct on the basis of the record maintained during ordinary course of business of CPCB and available records and documents and the contents of the same are read over and explained to me and are not repeated herein for the sake of brevity.



Anamika Sagar
DEPONENT

अनामिका सागर / Anamika Sagar
वैज्ञानिक 'ई' / Scientist 'E'
केंद्रीय प्रदूषण नियंत्रण बोर्ड
Central Pollution Control Board
(पर्यावरण, वन एवं जलवायु परिवर्तन मंत्रालय, भारत सरकार)
(M/o Environment, Forest & Climate Change, Govt. of India)
परिवेश भवन, पूर्व अर्जुन नगर, दिल्ली-110032
Parivesh Bhawan, East Arjun Nagar, Delhi-110032

VERIFICATION:**18 NOV 2025**

Verified at New Delhi on this _____ day of _____ 2025 that the contents of the above reply are correct and true on the basis of the records of the case as mentioned in the day-to-day affairs of the CPCB. Nothing has been concealed therefrom or mis-stated.



ATTESTED
RL
NOTARY PUBLIC
GOVT. OF INDIA

18 NOV 2025

Anamika
DEPONENT

अनामिका सागर / Anamika Sagar
वैज्ञानिक 'ई' / Scientist 'E'
केंद्रीय प्रदूषण नियंत्रण बोर्ड
Central Pollution Control Board
(पर्यावरण, वन एवं जलवायु परिवर्तन मंत्रालय, भारत सरकार)
(M/o Environment, Forest & Climate Change, Govt. of India)
परिवेश भवन, पूर्वी अर्जुन नगर, दिल्ली-110022
Parivesh Bhawan, East Arjun Nagar, Delhi-110022

Item No. 02

Court No. 1

**BEFORE NATIONAL GREEN TRIBUNAL
PRINCIPAL BENCH, NEW DELHI**Appeal No. 57/2025
(IA No. 587/2025)

Devesh Kumar Verma

Appellant

Versus

Environment, Forest and Climate Change,
Department (DOEFCC), Govt. of U.P. & Ors.

Respondent(s)

Date of hearing: 04.09.2025

**CORAM: HON'BLE MR. JUSTICE PRAKASH SHRIVASTAVA, CHAIRPERSON
HON'BLE DR. A. SENTHIL VEL, EXPERT MEMBER
HON'BLE MR. SUDHIR KUMAR CHATURVEDI, EXPERT MEMBER
HON'BLE DR. SUJIT KUMAR BAJPAYEE, EXPERT MEMBER**

Appellant: Mr. Saurabh Tiwari, Adv. (Through VC)

ORDER

1. By this Appeal filed under Section 18(1) read with Section 16 of the National Green Tribunal Act 2010. Appellant has challenged the appellate order dated 23.07.2025, whereby the appeal against the original order dated 04.02.2025 has been allowed.
2. There is a delay in filing this appeal, therefore, I.A. No. 587/2025 has been filed seeking condonation of the delay.
3. Issue notice of I.A. No. 587/2025 to the respondents. The appellant is directed to serve the respondents and file affidavit of service.
4. List on 24.11.2025.

Prakash Shrivastava, CP

231

Dr. A. Senthil Vel, EM

Sudhir Kumar Chaturvedi, EM

Dr. Sujit Kumar Bajpayee, EM

September 04, 2025
Appeal No. 57/2025
HB

MINISTRY OF ENVIRONMENT AND FORESTS

NOTIFICATION

New Delhi, the 16th March, 2012

G.S.R. 152(E).—In exercise of the powers conferred by sections 6 and 25 of the Environment (Protection) Act, 1986 (29 of 1986), the Central Government hereby makes the following rules further to amend the Environment (Protection) Rules, 1986, namely:-

1. (1) These rules may be called the Environment (Protection) Amendment Rules, 2012.
- (2) They shall come into force on the date of their publication in the Official Gazette.
2. In the Environment (Protection) Rules, 1986, in Schedule I, for serial number 69 relating to 'Flour Mills' and entries relating thereto, the following serial number and entries shall be substituted, namely:-

| Sl. No. (1) | Industry (2) | Parameter (3) | Standards (4) | |
|--|---|------------------------------|------------------------------|--|
| "69. | Grain Processing, Flour Mills, Paddy Processing, Pulse Making or Grinding Mills | A.-Emission Standards | | |
| | | | Capacity (tonne per hour) | Limiting Concentration in mg/Nm ³ |
| | | Particulate matter | 1 to 3 | 150 |
| | | | More than 3 | 100 |
| <p>Notes:-</p> <p>(i) All dust generating equipments or processes shall be provided with dust extraction arrangement.</p> <p>(ii) The bag houses, etc., shall be connected to chimneys/stacks of 12 metres height or at least 02 metres above the top most point of the building or shed or plant in the industry.</p> <p>(iii) The unit shall channelise shop floor/fugitive emissions through a stack of 12 metres height or at least 02 metres above the top most point of the building or shed or plant in the industry.</p> | | | | |

| (1) | (2) | (3) | (4) | |
|-----|-----|---------------------|--|--------------|
| | | | B.- Effluent Standards | |
| | | | Limiting value for concentration in mg/l, except for pH | |
| | | | Inland surface water | Public sewer |
| | | | Land for irrigation | |
| | | pH | 5.5-9.0 | 5.5-9.0 |
| | | Suspended Solids | 100 | 600 |
| | | Oil & Grease | 10 | 20 |
| | | BOD, 3 days at 27°C | 30 | 350 |
| | | COD | 250 | - |
| | | | C.-Stormwater Standards | |
| | | | <p>(i) Stormwater for a unit (having plot size atleast 250 square meters) shall not be allowed to mix with scrubber water, effluent and/or floor washings.</p> <p>(ii) Stormwater within the battery limits of a unit shall be channelized through separate drain/pipe passing through a HDPE lined pit having holding capacity of 10 minutes (hourly average) of rainfall."</p> | |

[F.No.Q-15017/33/2007-CPW]
RAJNEESH DUBE, Jt. Secy.

Note: The principal rules were published in the Gazette of India vide number S.O. 844 (E), 19th November, 1986 and subsequently amended vide notification numbers S.O. 433 (E), dated 18th April 1987; G.S.R. 512 (E), dated the 9th July, 2009; G.S.R. 543 (E), dated the 22nd July, 2009; G.S.R. 595 (E), dated the 21st August, 2009; G.S.R. 794 (E), dated the 4th November, 2009; G.S.R. 826 (E), dated the 16th November, 2009; G.S.R. 01 (E), dated the 1st January, 2010; G.S.R. 61 (E), dated 5th February, 2010; G.S.R. 485 (E), dated 9th June, 2010; G.S.R. 608 (E), dated 21st July, 2010; G.S.R. 739 (E), dated the 9th September, 2010; and G.S.R. 809(E), dated, 4th October, 2010, G.S.R. 215 (E), dated, the 15th March, 2011; G.S.R. 221(E), dated, the 18th March, 2011; G.S.R. 354 (E), dated, the 2nd May, 2011; G.S.R. 424 (E), dated, the 1st June, 2011; and G.S.R. 446 (E), 13th June, 2011.

**“Guidelines for
(i) Siting of rice shellers/mills;
(ii) handling and storage of rice husk and
(iii) handling, storage and disposal of ash
generated in boiler using rice husk as fuel”**



**CENTRAL POLLUTION CONTROL BOARD
MINISTRY OF ENVIRONMENT & FORESTS**

Website: www.cpcb.nic.in



मीरा महर्षि
अध्यक्ष

MIRA MEHRISHI
Chairman

केन्द्रीय प्रदूषण नियंत्रण बोर्ड
(भारत सरकार का संगठन)
पर्यावरण एवं वन मंत्रालय
Central Pollution Control Board
(A Govt. of India Organisation)
Ministry of Environment & Forests
Phone : 22304948 / 22307233

FOREWORD

Rice Processing mills are located in paddy producing regions spread over various States in India; like Assam, Punjab, Haryana, Tamil Nadu, West Bengal, Uttar Pradesh, Bihar, Orissa, Andhra Pradesh and Madhya Pradesh. Rice processing mills have adopted a blend of conventional methods and modern technology. Presently, two types of processing are in practice one-Raw Rice Processing (Rice Shellers) and other-Parboiled Rice Processing. Raw Rice or White Rice is the one obtained from untreated paddy, while the parboiled rice is obtained by milling the pretreated paddy. Pre-treatment is given to paddy to improve nutritional and cooking qualities of rice.

Rice Milling is a polluting industry. It discharges process waste water, particulate matter and solid waste. Rice husk is the largest by-product of rice milling industry which amounts to approximately 22-24 percent of the total paddy. The Rice Husk is used as a fuel to generate steam through boilers/furnaces resulting into Rice Husk Ash which needs to be disposed properly. For every 1000 kgs of paddy milled, about 220-240 kgs of husk is produced, and when this husk is burnt in the boilers, about 55-60 kgs (25%) of Rice Husk Ash is generated.

Considering the problem in handling of Rice Husk and Rice husk ash, Central pollution Control Board entrusted a project on Framing the Guidelines for (i) Siting of Rice Shellers/Mills; ii) Handling and Storage of Rice Husk and (iii) Handling, Storage and Disposal of Ash Generated in Boiler using Rice Husk as Fuel to the Federation of Indian Chambers of Commerce and Industry (FICCI).

The present document envisages production processes in Rice Mills, current practices adopted for handling & storage of rice husk and handling, storage & disposal of rice husk fired boiler ash. The present guidelines including Siting Criteria are based on the findings of the study.

I would like to thank FICCI for preparing the document and Shri U.N. Singh, Additional Director, Shri Abhey Singh Sr. Environmental Engineer and Ms. Alka Srivastava, Jr. Scientific Assistant for the sincere efforts made for bringing out this comprehensive document under the overall supervision and guidance of Sh. J.S. Kamyotra, Member Secretary, CPCB.

I hope this document will be useful for Rice Mill owners, Pollution Control Implementing Agencies and all other stakeholders concerned with the Environmental Management.

September 24, 2012

(Mira Mehrishi)

'Parivesh Bhawan' C.B.D.-cum-Office Complex, East Arjun Nagar, Delhi-110 032
Fax : 22304948 / 22307078 e-mail : ccb.cpcb@nic.in
Website : cpcb.nic.in

Prepared & Published by P R Division, Central Pollution Control Board
on behalf of Sh. J.S. Kamyotra, Member Secretary, CPCB
Printing Supervisor and Layout Ms. Anamika Sagar and Satish Kumar

237

Content

| S. No. | Title | Page Nos. |
|---|--|--------------|
| | List of Tables | v |
| | List of Figures | vii |
| | List of Abbreviations | ix |
| | Executive Summary | xii |
| Chapter 1: Introduction | | 1-3 |
| 1.1 | Background | 1 |
| 1.2 | Scope of Work | 2 |
| 1.3 | Methodology | 3 |
| Chapter 2: Selection of Representative Rice Mills for the study | | 5-6 |
| 2.1 | Scale of Operation | 5 |
| 2.2 | Type of Rice Produced | 5 |
| 2.3 | Age of Technology | 5 |
| 2.4 | Location of the unit | 6 |
| Chapter 3: Description of Production processes in rice mills | | 7-14 |
| 3.1 | Production Process in Parboiled Rice Mills | 7 |
| 3.2 | Production Process in White (Raw) Rice Mills | 10 |
| Chapter 4: Current Practices in the Mills for handling and storage of rice husk and handling, storage & disposal of rice husk fired boiler ash | | 15-24 |
| 4.1 | Practices for handling and storage of rice husk | 15 |
| 4.2 | Practices for handling, storage & disposal of rice husk fired boiler ash | 20 |
| Chapter 5: Fugitive emissions and Environmental Aspects in Rice Mills | | 25-40 |
| 5.1 | Typical Sources of Fugitive Emissions in rice mills | 31 |
| 5.2 | Fugitive emission control systems adopted | 32 |
| 5.3 | Overall Observation on Fugitive Emissions | 38 |
| Chapter 6: Characterization & Quantification of Pollutants and Fugitive Emissions in Rice Mills | | 41-60 |
| 6.1 | Field Measurements Conducted | 41 |
| Chapter 7: Fugitive Emissions in Rice Mills | | 61-62 |
| 7.1 | Escape of Unextracted fine dust from Paddy unloading area | 61 |
| 7.2 | Fugitive emissions of unextracted & uncaptured fines from paddy cleaning section | 61 |
| 7.3 | Unextracted fines from Milling Section | 61 |
| 7.4 | Unextracted fine dust particles in Husk Stored in open area | 62 |
| 7.5 | Re-entrainment of fines from Open storage & Disposal Practices | 62 |

| | | |
|---|--|--------------|
| Chapter 8: Analysis of Existing dust control arrangements & possible modifications for improvement | | 63-74 |
| 8.1 | Dust extraction system from paddy cleaning section | 63 |
| 8.2 | Dust extraction system from for milling section | 65 |
| 8.3 | Dust Extraction System for small Capacity Rice Mills | 67 |
| 8.4 | Rice Husk Handling & Storage Practices | 68 |
| 8.5 | Blowing of husk in storage area | 70 |
| 8.6 | Technical specifications of volume to be extracted from various material handling equipments | 70 |
| 8.7 | Typical Volume to be extracted from various locations | 72 |
| 8.8 | Literature Data on Typical Efficiency of Control Devices for Various Size Particles | 73 |
| 8.9 | Conclusion | 73 |
| Chapter 9: Utilization of Rice Husk Ash | | 75-80 |
| 9.1 | A number of possible uses of Rice Husk Ash | 75 |
| 9.2 | Uses of RHA in manufacturing Pozzolana Cement | 76 |
| 9.3 | Grinding of RHA for use in Cement Production | 77 |
| 9.4 | Utilization of Rice Husk in Lime Stabilization of poor soils | 78 |
| 9.5 | Other uses of Rice Husk Ash | 79 |
| 9.6 | Some Definitions related to Rice Husk/Ash utilization | 79 |
| 9.7 | Possible alternate uses of Rusk Husk than as Boiler Fuel | 79 |
| Chapter 10: Proposed Guidelines & Siting Criteria for Rice Mills | | 81-83 |
| 10.1 | Guidelines for Handling, Storage & transport of Rice husk | 81 |
| 10.2 | Guidelines for Handling, Transportation, Storage & disposal of ash from husk fired Boiler | 82 |
| 10.3 | Siting Criteria for new rice mills | 83 |

List of Annexure

Annexure 1: List of Rice Mills visited for the Study

Annexure 2: Copy of Rice Mills Questionnaire for Preliminary visits

Annexure 3: Data Sheet of Traverse Points Standard Protocol

Annexure 4: Data sheet for point source emission monitoring

Annexure 5: Literature Data on percentage of fines in dust in Grain Mills

Annexure 6: Reference Papers

Bibliography

239

LIST OF TABLES

| Table No. | Particulars | Page No. |
|------------------|--|-----------------|
| 2.1 | List of rice mills where preliminary visits were made | 6 |
| 2.2 | List of rice mills selected for detailed field studies | 6 |
| 5.1 | Typical Sources of Fugitive emissions in Rice Mills | 31 |
| 6.1 | Type of Monitoring carried out in 7 representative units. | 41 |
| 6.2.1 | Typical Collection Efficiencies of APCDs | 46 |
| 8.4.1 | Typical Ash Balance for various size Rice Mills | 68 |
| 8.4.2 | Composition of Rice Husk Ash on Dry Basis | 69 |
| 8.4.3 | % Carbon in Rice Husk Ash Samples from various Rice Mills | 69 |
| 8.4.4 | Typical Storage Area Required for Various Capacity Mills | 70 |
| 8.6 | Technical Specification for Dust Extraction | 70 |
| 8.7 | Typical Volume to be extracted from various locations for a large size Rice mill | 72 |
| 8.8 | Typical Collection Efficiencies of APCDs | 73 |
| 9.4 | Typical uses of rice husk ash and carbonize rice husk | 75 |
| 9.5 | Technical Specifications of Silpozz | 76 |

240

LIST OF FIGURES

| Figure | Particulars | Page No. |
|--------|---|----------|
| 3.1 | Vibratory Screens | 7 |
| 3.2 | Destoner | 8 |
| 3.3 | Parboiling of Rice | 8 |
| 3.4 | Mechanical Dryers | 9 |
| 3.5 | Sun Drying of Parboiled Paddy | 9 |
| 3.6 | Paddy Cleaner | 9 |
| 3.7 | Hullers | 9 |
| 3.8 | Aspirators | 10 |
| 3.9 | Process Flow Diagram of Parboiling Rice Production | 11 |
| 3.10 | Main Sections of Typical Small White Raw Rice Mills | 12 |
| 3.11 | Process Flow Diagram of White Raw Rice Production | 13 |
| 4.1 | Husk Blown to Storage Yard in Small Scale Mills | 15 |
| 4.2 | Husk Handling in Small Scale Mills | 15 |
| 4.3 | Husk Handling in Large Scale Mills | 16 |
| 4.4 | Dust Extracted through Cyclone | 16 |
| 4.5 | Rice husk conveyance in storage yard using conveyor belts in large mills | 16 |
| 4.6 | Rice husk storage in fully open area with boundary walls | 17 |
| 4.7 | Heaps of rice husk in the fully open storage area with extended pipes | 18 |
| 4.8 | Fully open storage of rice husk without separating fines | 18 |
| 4.9 | Large quantities of husk storage with tall fencing | 19 |
| 4.10 | Rice Husk Storage in Closed Room | 19 |
| 4.11 | Husk Handling from storage yard to boiler using conveyor belts in large mills | 19 |
| 4.12 | Husk loading for transportation & selling | 20 |
| 4.13 | Mechanical handling of boiler ash | 21 |

| Figure | Particulars | Page No. |
|--------|--|----------|
| 4.14 | Open storage of husk fired boiler ash | 21 |
| 4.15 | Partially covered storage of husk fired boiler | 21 |
| 4.16 | A Closed storage of husk fired boiler ash | 22 |
| 4.17 | Boiler ash Disposal land-fill site | 22 |
| 4.18 | Layer of soil after disposal of boiler ash | 22 |
| 4.19 | Plantation in the boiler ash disposal | 22 |
| 5.1 | Paddy Unloading | 25 |
| 5.2(a) | Bucket Elevator | 25 |
| 5.2(b) | Conveyer | 25 |
| 5.3 | Silo | 25 |
| 5.4 | Paddy Cleaner | 25 |
| 5.5 | Vibratory Screens | 26 |
| 5.6 | Conveyers & BE | 26 |
| 5.7 | De-huskers | 26 |
| 5.8 | Polishers and Graders | 27 |
| 5.9 | Aspirators | 27 |
| 5.10 | Rice Husk Storage Areas and conveyance systems | 27 |
| 5.11 | Boiler section and ash generation | 28 |
| 5.12 | Fly ash deposited on ground near boiler section due to Fugitive Emissions | 28 |
| 5.13 | Fugitive Emissions from Boiler Ash temporary storage area | 29 |
| 5.14 | Re-entrainment of boiler ash particles from unprotected 7 dry disposal sites | 29 |
| 5.15 | Typical Fugitive Emission Sources in Rice Mills | 30 |
| 5.16 | Extraction Hood near Bucket Elevator in large mills | 32 |
| 5.17 | Cyclone followed by Bag Filter at Pre-Cleaner in large mills | 33 |
| 5.18 | Various flexible suction pipes sucking from various equipments and passed through a common cyclone in small rice mills | 33 |
| 5.19 | Proper dust extraction system with cyclone and ID fan in | 34 |

| Figure | Particulars | Page No. |
|--------|---|----------|
| 5.20 | Large mills various suction ducts from milling section to a common cyclone in small rice mills | 34 |
| 5.21 | Suction ducts from polisher to cyclone for bran separation in small rice mills | 34 |
| 5.22 | Cyclone for collection of boiler ash in large and medium rice mills | 35 |
| 5.23 | Dust Extraction cum Control Systems Adopted in Small White (Raw) Rice Mills | 36 |
| 5.24 | Extraction cum Control Systems Adopted in Large and Medium Scale Mills | 37 |
| 6.1 | Inclined Manometer used for Velocity Measurement | 42 |
| 6.2 | Stack Monitoring Kit | 42 |
| 6.3 | Respirable High Volume Sampler | 42 |
| 6.4 | Port Hole at Cyclone | 45 |
| 6.5 | Cyclone followed by Bag Filter | 45 |
| 6.6 | Pre-Cleaning | 46 |
| 6.7 | Common Duct from Paddy Separators (2 nd floor) | 49 |
| 6.8 | ID Fan Inlet (Port Hole 8) on 4 th Floor | 49 |
| 6.9 | Outlet from Single Huller (Port Hole 4) on 3 rd floor | 49 |
| 6.10 | Cyclone Inlet (Port Hole 7) on 4 th floor | 49 |
| 6.11 | Ground Floor (Milling Section) | 50 |
| 6.12 | 4 th Floor of Milling Section | 50 |
| 6.13 | Near Factory Gate | 51 |
| 6.14 | Near ETP | 51 |
| 6.15 | Near Plant Colony | 51 |
| 6.16 | Windward Side (RDS) | 52 |
| 6.17 | Leeward Side (RDS) | 52 |
| 8.1 | Comparison of Existing vs Required Dust Extraction cum Control System for Rice Mills (for paddy cleaning section) | 67 |
| 8.2 | Typical Set of Paddy Unloading to Cleaning Section showing "Required Dust Extraction Locations" | 71 |

243

ABBREVIATIONS

| | |
|------|------------------------------------|
| CPCB | Central Pollution Control Board |
| TSP | Total Suspended Particulates |
| LPM | Liters per minute |
| PM | Particulate Matter |
| mmWc | Millimeters of Water Column |
| TSPM | Total Suspended Particulate Matter |
| RDS | Respirable Dust Sampler |
| ID | Induced Draft |
| OPC | Ordinary Portland Cement |
| RHA | Rice Husk Ash |
| APCD | Air Pollution Control Device |
| PCB | Pollution Control Board |
| BE | Bucket Elevator |
| BC | Belt Conveyer |

244

EXECUTIVE SUMMARY

Typically, the rice processing units in the country are small, medium and large size mills. Most of them are situated in the paddy producing regions spread over various States in India. For study purpose units from each category - small, medium and large scale were selected. The scale of operation of selected rice mills varies from as small as 1 tonne/hr upto 50 tonne/hr or more. Typically, mills with capacity less than 3 tonne/hr can be categorized as Small Mills, 3 to 15 tonne/hr capacity as Medium and greater than 15 tonne/hr capacity as Large. Most of the large and medium units generally produce both the Parboiled and White (Raw) Rice using separate production lines. However, most of the small scale units generally produce White (Raw) rice. For the purpose of the study units producing both Parboiled and White (Raw) Rice and units producing only Raw Rice were selected, so as to cover various unit operations, such as cleaning, parboiling, drying, hulling, dehusking, polishing and sorting, etc. Some of the rice mills are located in clusters in industrial areas, away from residential areas, some in residential areas and some even in the middle of the agriculture/paddy fields. For the purpose of the study units in all the above three locations were selected. 11 units were identified for Preliminary visits based on the selection criteria. Out of 11 units, 7 units were selected for detailed field studies.

Rice husk is the largest by-product of rice milling industry which amounts to 22-24 percent of the total paddy. The units need to handle the bulk quantities of husk and store them within the unit premises till husk is used or sold. During the milling of paddy, rice husk is separated out in the de-husker machines and husk is sent to storage yard in many ways depending upon the mill scale, type and mechanism employed. In most of the small mills husk from de-husker is simply blown to storage yard with help of blowers. In most of the large mills the husk is extracted from aspirators and it is collected on the conveyor belt. From conveyor belt the husk is conveyed to the storage yard. From extraction system, the fines/dust is taken to cyclone from where the dust/fines separate out and falls from the bottom of cyclone. But major portion of the Fine Particles not collected in cyclones, escape to atmosphere from discharge of the Induced Draft Fan.

Most of the small units have a common open storage of rice husk, rice bran and also the dust collected by the Paddy Cleaner. The units have different practices for storing the rice husk like fully open storage with boundary wall, partially covered storage and completely covered storage. Most of the small and medium units store the rice husk in open area within their premises. However, most of the small and medium mills have 10 foot boundary wall surrounding the husk storage areas. Separated Rice Husk from de-husker is blown to storage yard with help of blowers without separating fines. Therefore the stored husk in these small mills has more percentage of fines which gets air-borne during windy period. Most of the large units have covered their husk storage areas partially with tall fencing, to combat with large quantity of stored husk and to reduce the fugitive emissions from the storage yard. Few medium and large units have covered storage yards for storing rice husk. The storage of rice husk in closed space eliminates the possibility of fines blowing with the wind besides reducing the fugitive emissions. Most of the medium and large mills use covered conveyor belts (mechanical system) for handling husk from storage area to boiler. Most of the parboiled units use the rice husk as boiler feed for steam generation and for electricity generation in captive power plants. After the combustion of rice husk in boiler the boiler ash is generated which needs to be handled, stored and disposed. Most of the medium and large scale units handle their boiler ash

mechanically and collect it in the trucks/trolley, directly from boiler, with the help of conveyor belt and hoppers. They also spray water over the collected ash in trucks and nearby boiler section to reduce the fly ash emissions. The Small Scale Rice Mills having small size Boilers generally handle the Boiler Ash manually, during collection from Boiler Section to Temporary Storage.

A large quantity of boiler ash is generated in the parboiled rice mills which need to be stored temporarily before its disposal. Many of the small & medium rice mills store their boiler ash in partially covered storages. Most of the large units dispose their boiler ash on part of their own land, converted as landfills. After disposal of boiler ash on the land it is covered with a layer of soil and plantation developed over. Recycled wastewater is periodically sprinkled on the ash disposal site to avoid wind blowing of fly ash in the nearby areas. Most of the small and medium mills not having their own disposal facilities generally dispose their husk ash, through contractors, who dispose it to available low lying areas. Most mills give this job on contract basis where the contactors collect the boiler ash from the unit premises and dispose it on payment basis. In this case even the generator of ash is not aware of the ultimate disposal site of its boiler ash. In the areas where use of boiler ash is common in fields by farmers, the mills or contractors also sell boiler ash for use in the farms.

In rice mills fugitive emissions are generated from various sections during handling of paddy; cleaning & milling of paddy; handling and storage of husk and handling, storage and disposal of boiler ash due to various activities in the mills. Monitoring of emissions was carried out in selected 7 representative units. For monitoring purpose three parameters were considered – Fugitive Emissions Assessment, Stack Monitoring and Ambient Air Quality Monitoring. In order to evaluate and quantify the air pollution problem, measurements were carried out for selected air pollutants. Fugitive Emission Assessment was carried out at Pre-cleaning Section, Milling Section and Boiler House. In Milling Section, Stack Monitoring was done at inlet and outlet of Paddy Cleaners, De-huskers, Aspirators, Polishers, etc as well at the Inlet and Outlet of Cyclones and ID Fans. Stack Monitoring was carried out in Rice Husk fired Boiler House, at Stack.

Due to free fall, substantial fine dust is generated during unloading of paddy and its conveyance. This fine dust escapes in the mill environment due to inadequate extraction arrangement from the Unloading pit, the Bucket Elevator, the Discharge Points, etc. In the milling section during husk removal substantial quantities of fine particles of rice husk are generated due to breaking of husk in hullers and husk separation in de-huskers. During milling of paddy fine rice husk escapes in the milling section. It is generally perceived that the fine dust adhering to paddy keeps getting loosened/ separated, right from bag unloading point upto the cleaning screen and it gets accumulated and can be extracted at the final point i.e. screen. But, because, the system of conveying & storage of paddy is not air-tight hence the fine dust, as and when generated, escapes to atmosphere through the openings/leakages in the system. Even if all the leakages/openings are closed or sealed, the fine dust would escape through the vent of the storage vessel, through openings for discharging material. It is, therefore, necessary to extract / suck the fine dust particles from various locations simultaneously like transfer points, point of free fall Paddy, vents of storage bins/ silos, vibratory/rotary screens etc. Even though large volume of extraction is provided (about 15000 Nm³/h) which may be even more than that required (as per the technical design handbook specifications), but still not able to extract the dust emissions adequately resulting in substantial fugitive emissions, because all the sucking is provided

only at 1 point i.e. the vibratory screen, which is a wrong design instead of sucking dust from various required locations like belt conveyor transfer points, bucket elevators, storage silos etc.,

In nutshell, even if the industry has installed more than adequate size of dust extraction cum bag filter system and have made substantial investment on the equipment, associated with high operating costs of running the ID fan, still substantial fugitive emission occur, thereby defeating the very purpose of installing dust extraction cum control system. This is primarily because of in-appropriate design of dust extraction network and improper maintenance of the cyclone and bag filter leading to leakages in the system and high pressure drop in bag filter. Therefore, it is necessary to provide technical guidance to rice mills for the required volume of air to be extracted from various locations.

Husk contains about 75 % organic volatile matter and the balance 25% of the weight of this husk is converted into ash during the firing process, known as Rice Husk Ash (RHA). This RHA in turn contains around 80% - 90% silica. For every 1000 kgs of paddy milled, about 220 kgs (22 %) of husk is produced, and when this husk is burnt in the boilers, about 55 kgs (25 %) of RHA is generated. Presently, many rice mills blow the husk (from the de-husker) by a blower in the open area outside the factory shed wall. The husk falls to ground by gravity & forms heap. The size of heap keeps growing as more & more husk is blown. This openly stores husk leads to generation of dust due to wind blowing. To avoid this environmental air pollution problem, the blowing of husk should be done into a closed room. The room should be provided with an access door (to be kept closed during blowing) and a vent in the roof to release the air. The vent pipe should be attached to a filter-bag arrangement to arrest the fine particles. The size of the room would depend on the quantity of husk blown per hour & minimum storage quantity required.

Most rice mills do have some dust extraction arrangement but requires modifications to make the system appropriate so as to cover dust extraction from belt conveyor transfer points, bucket elevator & screens, storage silo vents etc. There are substantial fugitive emissions from area like paddy unloading section, paddy cleaning section, milling section etc. There are substantial leakages of air in the dust extraction system from cyclone bottom opening, bag-filter casing, flanges and joints etc, which reduces the useful dust extraction volumes sucked by the induced draft fan.

Thus, urgent measures need to be taken to improve the environmental performance of Rice Mills. Keeping in view the orders passed by the court and the gravity of air pollution caused by this sector, guidelines have been evolved (Chapter 10 of the report) for proper Handling and Storage of Rice Husk; Handling, Storage and Disposal of Boiler Ash and Siting Criteria for New Rice Mills.

INTRODUCTION

1.1. Background

Primary milling of rice is an important activity in food grains. Rice is used in almost all parts of India. Few decades ago, rice grains were processed at family level before cooking. Today, due to Industrialization and global competitive market trend, it has emerged as one of the major industrial activity in tiny, small, medium and large scale sector to cater to the needs of increasing population. Large number of mills engaged in processing/milling of rice are spread over in almost all states across the country. Due to increasing demand the number of rice mills will continue to increase throughout the country.

The input to the Rice mill is paddy whereas the output is parboiled rice and raw /white rice depending upon whether the pretreatment is given to paddy or not. The objective of milling is to get whole grain rice and preserve most of the rice kernels in their original shape. The technologies used for rice milling in tiny and small mills are mostly conventional in nature and are not oriented towards minimizing pollution by incorporation of in plant pollution prevention cum control measures. These units generate substantial amount of pollution, especially air pollution as a result of fugitive emissions from various operations.

The pollution is particularly high in cleaning of paddy, parboiling of paddy and milling of rice. Primary and secondary cleaning of paddy gives rise to solid waste and fugitive emission in the work environment. The coal or husk fired boiler generates fly ash, suspended particulate matter, smoke, and oxides of carbon. Residents of nearby towns suffer due to pollution generated by rice mills. Though some of changes are being brought in production processes to improve the efficiency and lowering the cost of production etc., as regards to pollution abatement & control it remains mostly unsatisfactory. A Civil Writ came up for hearing before the Punjab and Haryana High Court recently and during hearing, the Hon'ble Court had passed an interim order: "*It be made known as to why rice husk etc. cannot mandatory be required to be stored, after expulsion by the machine, directly into an enclosed area, so that it does not in any way get out of the factory premises on to the crops/ passing vehicles/any residence made in open fields/on farm workers, at all.*" In compliance of the orders passed by the court, Punjab Pollution Control Board carried out a study so that some immediate action could be taken to prevent air pollution in the surrounding areas by following enclosed storage practices. The study included inspection of shellers of different capacities, measures taken by these shellers to store the Rice Husk in an environmentally sound manner, adequacy of the enclosure provided around the rice husk storage area, etc. After going through recommendations of the study, court expressed that problem of spillage of Rice Husk could not be solved without providing air tight enclosures. The court also expressed that loading/handling of Rice Husk should be inside the air tight enclosure, so as to rule out any possibility of rice husk particles becoming air borne. The handling and proper disposal of Rice Husk Ash is also a big problem. The ash deposited in the nearby areas is causing health impacts to humans as well as plants.

Keeping in view the orders passed by the court and the gravity of air pollution caused by this sector, Central Pollution Control Board entrusted a project on 'framing the guidelines for siting of rice shellers/mills; handling and storage of rice husk and handling; storage and disposal of ash generated in boiler using rice husk as fuel' to Federation of Indian

Chambers for Commerce and Industry, so as to improve the environmental performance of the rice mills.

1.2. Scope of Work

The scope of work of the study is given below:

- Study of current practices in the mills for:
 - Handling of rice husk and control of dust emissions
 - Storage of rice husk and control of dust emission
 - Ash handling and Control of dust emissions from Rice Husk Fired Boilers
 - Ash Storage and its disposal from Rice Husk Fired Boiler
 - Siting issues related to locations, transportations, storages etc.
- Fugitive Emissions Assessment using samplers for estimating emissions from following sections:
 - Paddy cleaning section covering operations like unloading of paddy, pre-cleaning (Chalni), paddy cleaning in paddy cleaner/ vibrating screen etc.
 - Milling Section covering different stages of lifting and discharging of paddy /rice through bucket elevator, dehusking in rubber roll, aspirator used for husk removal, polishing & grading of rice in rice grader.
 - Storage section of rice husk & boiler ash.
- Stack Monitoring in Pre-Cleaning and Milling Section.
- Compilation of measured data & its analysis to evolve specific aspects related to fugitive dust emissions.
- To evolve practically adoptable system for proper handling and storage of rice husk and handling, storage & disposal of boiler ash.
- To frame guidelines for handling and storage of rice husk and handling, storage & disposal of boiler ash
- To evolve siting criteria for new rice shellers/ mills.
- Presentation of report recommendations to CPCB expert committee & discussions.
- Incorporating CPCB suggestions and submission of final report.

1.3. Methodology

While framing the guidelines for the rice milling sector, the following methodology was adopted:

- **Literature Survey:** A detailed literature survey was conducted for collecting information on types of technologies used, current practices on handling & storage of husk/ash etc.
- **Information Collection:** The available data from various agencies like industry associations, CPCB, SPCBs and other government agencies about rice mill

technologies, practices for handling, storages etc was collected and reviewed.

- **Data Collection & Analysis:** 7 representative units were selected for detailed field studies, comprising Stack Monitoring, Fugitive Emissions Assessment and Ambient Air Monitoring. Additional number of units was also visited for dry studies & information collection.
- **Emission monitoring:** The study involved various aspects such as identification and characterization of sources of emission and emissions measurement in representative units. The particulate matter sampling was done as per method prescribed by CPCB.
 - Stack Monitoring: the measurements were carried out using stack monitoring instruments such as dry gas meter, vacuum pump assembly.
 - Air Quality Monitoring: Fugitive emissions assessment was conducted at work place in major sections of the units and ambient air quality monitoring was done using respirable/high volume samplers for measurement of TSPM & PM10.
- **Technology Assessment:** The available technologies in the rice mill sector in India for abatement, prevention and control of emissions were reviewed through discussions with Unit Management and collection of information from other sources regarding technologies used in this sector.
- **Framing of Guidelines:** The guidelines for Rice shellers/mills sector were framed keeping in view the information gathered and field study data.

SELECTION OF REPRESENTATIVE RICE MILLS FOR THE STUDY

Typically, the rice processing units in the country are small, medium and large size mills. Most of them are situated in the paddy producing regions spread over various States in India.

For the purpose of the study a number of rice mills were identified for preliminary visits based on the following criteria:

- Scale of Operation
- Type of Rice Produced
- Age of Technology
- Siting of the unit
- Type of fugitive emission control measures practiced

2.1 Scale of Operation

The number of Rice Mills present in India is quite large, which includes small, medium and large scale mills. For study purpose units from each category - small, medium and large scale were selected. The scale of operation of selected rice mills varies from as small as 1 tonne/hr upto 50 tonne/hr or more. Typically, mills with capacity less than 3 tonne/hr can be categorized as Small Mills, 3 to 15 tonne/hr capacity as Medium and greater than 15 tonne/hr capacity as Large.

2.2 Type of Rice Produced

Rice mills in India generally produce 2 types of rice, Parboiled Rice and White (Raw) Rice. In order to improve nutritional and cooking qualities of rice, pre-treatment is given to paddy. The rice obtained from milling pretreated paddy is known as parboiled rice, whereas the rice obtained from milling untreated paddy is known as raw rice or white rice.

Most of the large and medium units generally produce both the Parboiled and White (Raw) Rice using separate production lines. However, most of the small scale units generally produce White (Raw) rice. For the purpose of the study units producing both Parboiled and White (Raw) Rice and units producing only Raw Rice were selected, so as to cover various unit operations, such as cleaning, parboiling, drying, hulling, dehusking, polishing and sorting, etc.

2.3 Age of Technology

Rice processing methods adopted in India are a blend of conventional methods and modern technology. In small rice mills, normally conventional rice processing is prevalent. In large-scale mills, modern and state-of-art technology and equipments are used. For the purpose of the study units using both modern technologies as well as units with old conventional technologies were selected.

2.4 Siting of the unit

Some of the rice mills are located in clusters in industrial areas, away from residential areas, some in residential areas and some even in the middle of the agriculture/paddy fields. For the purpose of the study units in all the above three locations were selected.

The following 11 units were identified for Preliminary visits based on the selection criteria discussed above:

Table 2.1: List of rice mills where preliminary visits were made

| Unit Code No. | Milling Capacity | Scale of Operation | Type of Rice Produced | Age of Technology | Location |
|---------------|------------------|--------------------|------------------------------|-------------------|------------------|
| 1 | 55 tonne/hr | Large | White (Raw) Rice & Parboiled | Modern | Agriculture land |
| 2 | 3 tonne/hr | Small | White (Raw) Rice | Old | Agriculture land |
| 3 | 1 tonne/hr | Small | White (Raw) Rice | Old | Agriculture land |
| 4 | 12 tonne/hr | Medium | White (Raw) Rice & Parboiled | Modern | Residential Area |
| 5 | 2 tonne/hr | Small | Parboiled | Old | Residential Area |
| 6 | 5 tonne/hr | Medium | White (Raw) Rice | Modern | Agriculture land |
| 7 | 2 tonne/hr | Small | White (Raw) Rice | Old | Agriculture land |
| 8 | 2 tonne/hr | Small | Parboiled Rice | Old | Industrial Area |
| 9 | 1.2 tonne/hr | Small | Parboiled Rice | Old | Residential Area |
| 10 | 2 tonne/hr | Small | Parboiled Rice | Modern | Residential Area |
| 11 | 2 tonne/hr | Small | Parboiled Rice | Old | Residential |

Out of above 11 units, 7 units were selected for detailed field studies as shown in table below:

Table 2.2: List of rice mills selected for detailed field studies

| Unit Code No. | Milling Capacity | Scale of Operation | Type of Rice Produced | Age of Technology | Location |
|---------------|------------------|--------------------|------------------------------|-------------------|------------------|
| 1 | 55 tonne/hr | Large | White (Raw) Rice & Parboiled | Modern | Agriculture land |
| 2 | 3 tonne/hr | Small | White (Raw) Rice | Old | Agriculture land |
| 3 | 1 tonne/hr | Small | White (Raw) Rice | Old | Agriculture land |
| 4 | 12 tonne/hr | Medium | White (Raw) Rice & Parboiled | Modern | Residential Area |
| 5 | 2 tonne/hr | Small | Parboiled | Old + Modern | Residential Area |
| 8 | 2 tonne/hr | Small | Parboiled | Old | Residential |
| 11 | 2 tonne/hr | Small | Parboiled Rice | Old | Residential |

DESCRIPTION OF PRODUCTION PROCESSES IN RICE MILLS

The objective of rice milling is to get whole grain rice and preserve most of the rice kernels in their approximate original shape. In order to improve nutritional and cooking qualities of rice, a pre-treatment is given to paddy and the rice so obtained by milling the pretreated paddy is known as parboiled rice. The rice obtained from milling untreated paddy is known as raw rice or white rice. A brief overview of various stages/sections involved in parboiled rice processing is briefly discussed below:

3.1 Production Process in Parboiled Rice Mills:

3.1.1 Pre -Cleaning

Paddy which is stored in Bags is brought to the Unloading Area where bags are cut manually and Paddy is unloaded on Conveyers. It is then lifted via. Bucket Elevators to the Silos for Storage prior to Pre-Cleaning. Paddy stored in Silos is again lifted via. Bucket Elevators to the Pre-Cleaning Process. Prior to the actual milling operation, the paddy received from Silos is cleaned. Foreign matter or impurities are removed to protect the processing equipment and improve the final product. The impurities can be classified into large size impurities, small size impurities and impurities of about the same size as the paddy grains. Large impurities normally consist of rice straw, panicles, bag strings, soil stones, and sometimes iron parts. Small impurities consist of dust, sand, soil, weed seeds, insects and small stones. Impurities of about the same size as the paddy grains can be empty grains, stones and iron particles.

In the pre-cleaning process steps, different types of equipments are used depending upon size and weight of impurities. Small & large sized impurities are removed using sieving principle whereas; lighter/heavier impurities of similar size are removed using gravity separation or vibratory type screening machines as shown in Figure 3.1. Foreign material about the same weight and size as the paddy grain is difficult to remove and it is presumed to disintegrate into smaller sizes during the subsequent stages. The cleaned paddy is stored in bins & sent to subsequent processing.



Fig 3.1-Vibratory Screens

- **De-stoning**

Paddy after cleaning goes for de-stoning into the De-stoner machines for removal of impurities like stones as shown in figure 3.2. After De-stoning operation paddy is taken to further milling.

3.1.2 Parboiling of Pre-Cleaned Paddy

Parboiling is one of the latest well-developed pre-milling conditioning treatment given to paddy to improve its nutritional & cooking quality. In parboiling the paddy is soaked in water and subsequently steamed and dried, before milling as shown in figure 3.3. This helps in minimizing the breakage of rice and reducing the loss of nutrients during milling.

There are various methods of parboiling practiced in India; some are conventional methods while some are modern technology based methods. The conventional method of parboiling includes single boiling, double boiling and CFTRI hot soaking method.

The modern technology of parboiling includes chromate-soaking method, pressure parboiling method, the modified pressure parboiling method and dry heat parboiling. The benefits of the most of modern technologies are (i) No smell problem, (ii) Reduction in time of processing and (iii) Reduction in paddy drying time due to less moisture content in the paddy.



Fig 3.2- Destoner



Fig 3.3- Parboiling of Rice

3.1.3 Drying of Parboiled Paddy

Paddy, after parboiling, contains high moisture due to soaking and steaming, it may contain 35 to 40% moisture. After pressure parboiling, it may contain 20% to 30% moisture. In either case, it needs to be dried quickly to about 14% moisture for safe storage or for milling. Drying can be done either in the sun or in the hot air dryer as shown in figure 3.4 and 3.5. But whatever method of drying is employed, caution is to be exercised so that milling quality of paddy is not damaged. If drying is not proper, parboiled paddy can give very high breakage during milling. Generally, most mills employ a hot air type of drying. Hot air is passed through the paddy till it is dried to desired extent.



Fig 3.4 -Mechanical Dryers



Fig. 3.5 -Sun drying of Parboiled Paddy

3.1.4 Milling Process

The milling process broadly consists of final cleaning, de-husking/hulling, husk separation and Whitening/polishing.

- **Final Cleaning of Parboiled Paddy:**

Before De-husking, Paddy is cleaned again in Paddy Cleaners to remove impurities still present in the Paddy after Parboiling as shown in figure 3.6.

- **Hulling/ Dehusking:**

The objective of a hulling/dehusking operation is to remove the husk from the paddy grain with a minimum of damage to the bran layer and, if possible, without breaking the brown rice grain. Since, the structure of the paddy grain makes it necessary to apply friction to the grain surface to remove the husk; it leads to breaking of some of the rice.



Fig 3.6- Paddy Cleaner



Fig 3.7-Hullers

paddy is forced between the two discs and as a result of pressure and friction most of the paddy is dehusked (hulled).

Hulling machines are known by different names, such as shellers, hullers, dehuskers, huskers and hulling mills. Most commonly these machines are called “hullers”. The paddy is fed into the center of the machine through a small hopper as shown in figure 3.7. A vertically adjustable cylindrical sleeve regulates the capacity and equal distribution of the paddy over the entire surface of the rotating disc. By centrifugal force the,

- **Husk Separation:**

The discharge from a rice huller is a mixture of de-husked rice, husk and paddy. The mixture is transferred to screen for the separation of husk. A separator is used to screen the remaining paddy from the de-husked rice, generally called as “Aspirators” as shown in figure 3.8.



Fig 3.8-Aspirators (on left)

- **Whitening and polishing:**

In the process of whitening, the silver skin and the bran layer of the brown rice are removed. During polishing of the whitened rice, the bran particles still sticking to the surface of the rice are removed and the surface of the rice is slightly polished to give it a glazed appearance. Three kinds of whitening machines are widely used in the rice processing industry. They are- (i) the vertical abrasive whitening cone; (ii) the horizontal abrasive whitening machine; and (iii) the horizontal jet pearler.

- **Sorting, Grading and Packing:**

The whitened and polished rice is sorted with the help of sortex machines which rejects the rice on the basis of their color. The sorted rice is graded based on their length and packed for dispatch.

A schematic process flow diagram of parboiling rice production is given in figure 3.9.

3.2 Production Process in White (Raw) Rice Mills:

The production process of white or raw rice mills generally include cleaning, de-husking, un-husked paddy separation, polishing in 3 stages to obtain rice bran and finally grading of the milled rice. A process flow diagram of white raw rice mills is shown in figure 3.10.

After unloading of paddy it is carried to the Cleaner machine through the elevator where all dust, dirt, stones present in paddy are removed. Cleaned paddy is then carried to the huller machine via. Elevators where separation of husk from rice occurs. After hulling, the paddy is taken to separator/aspirator where unhusked paddy is separated from rice. Unhusked paddy is re-circulated to the hulling machine and brown rice is carried forward to the polishing machines. There were 3 to 4 Polishers in most of the small units. Rice bran separated in the polishing machines is collected through separating beds at each polisher in few units while in some units it is collected through Cyclones into Fine and

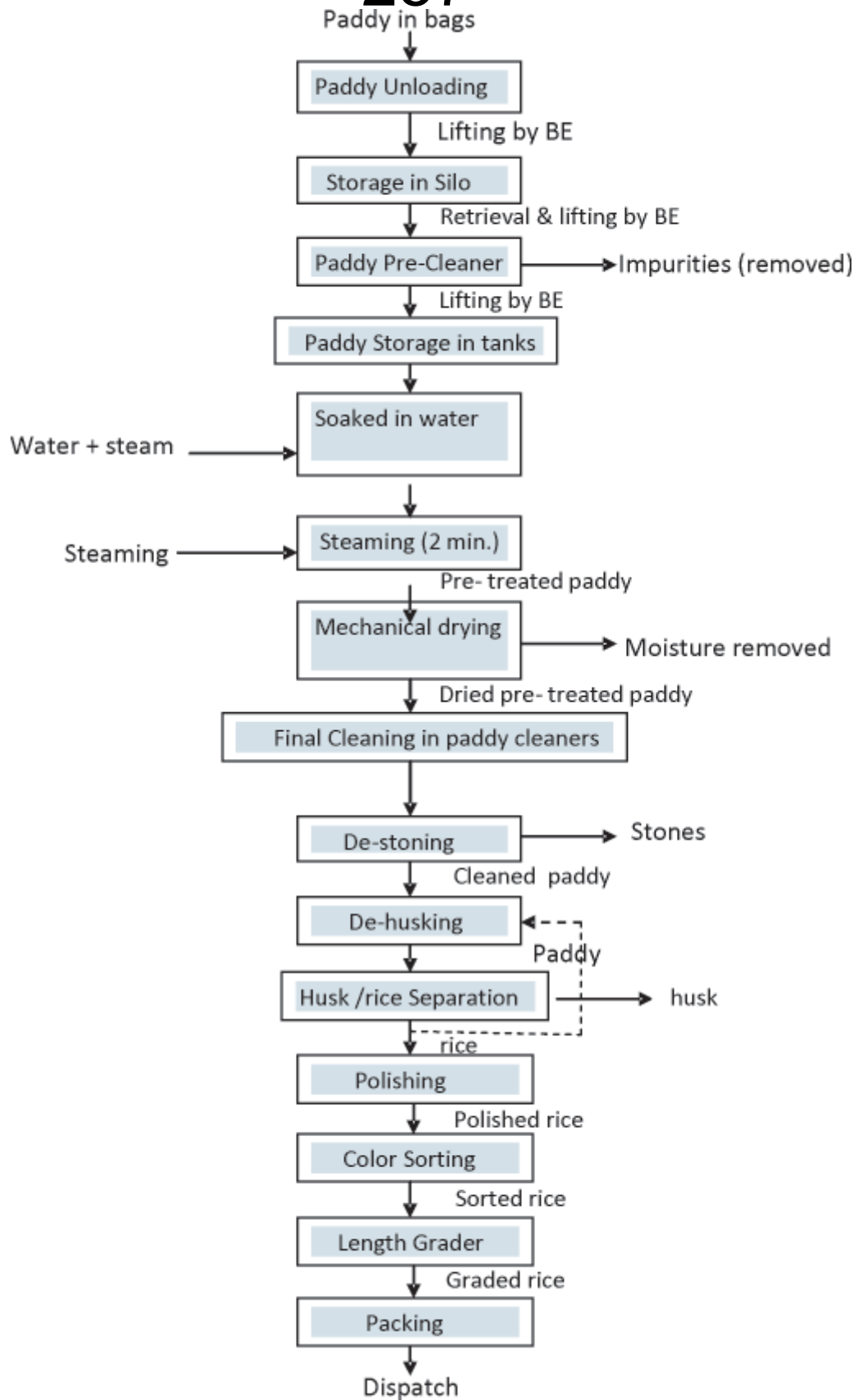

Fig: 3.9 - PROCESS FLOW DIAGRAM OF PARBOILING RICE PRODUCTION

Coarse Bran. White rice goes to the Graders where separation of Rice occurs according to the length and broken rice is separated from whole rice. A pictorial presentation of main process of small white raw rice mills is given in figure 3.10:



a. Paddy Unloading section



b. Paddy Cleaning Section



c. Hullers / De-huskers



d. Aspirator/ Paddy Separator



e. Polishers



f. Graders

Fig. 3.10- Main sections of typical small white raw rice mills

A process flow diagram of white raw rice production is given in figure 3.11.

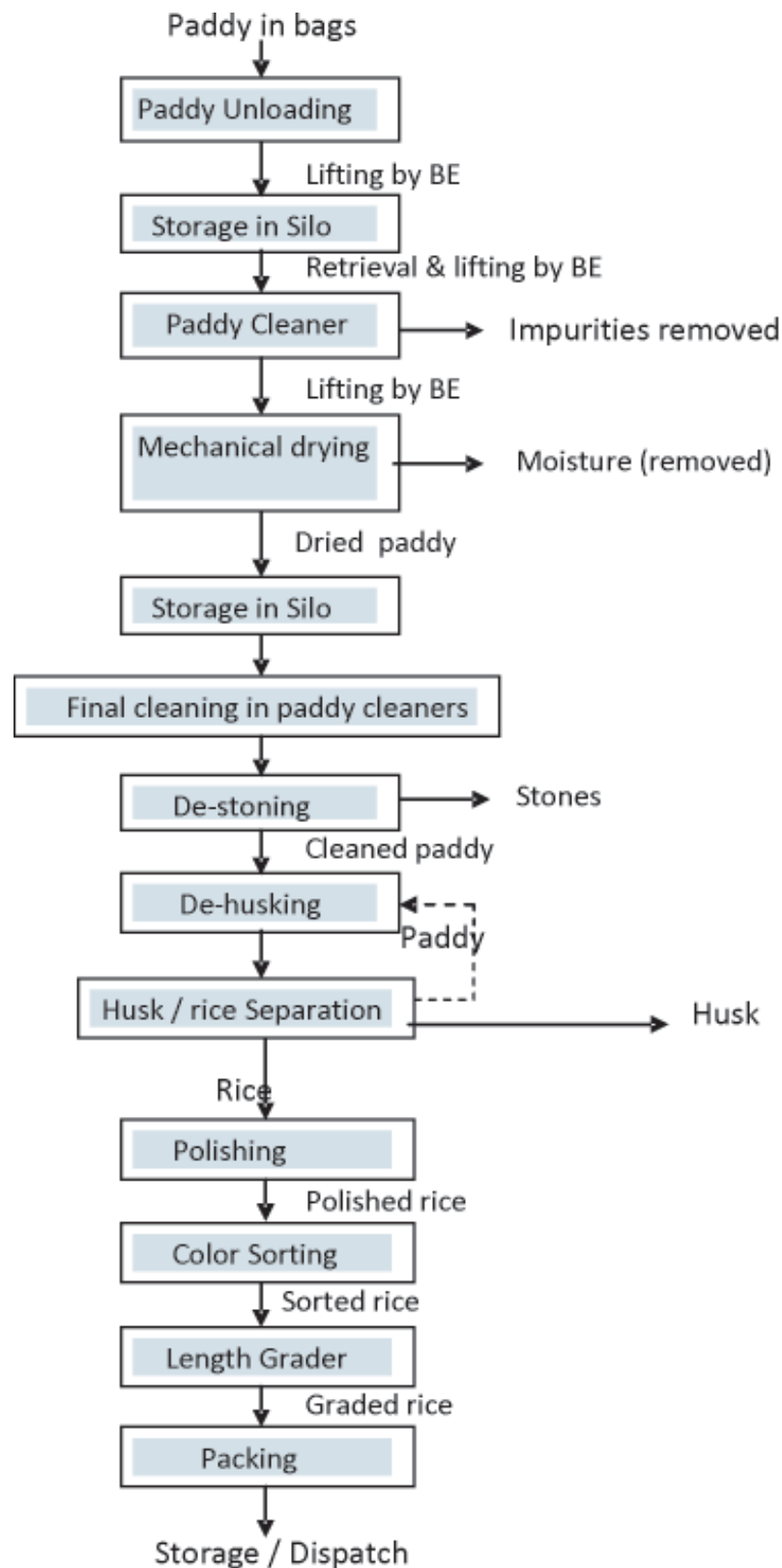

Fig. 3.11- PROCESS FLOW DIAGRAM OF WHITE RAW RICE PRODUCTION

CURRENT PRACTICES IN THE RICE MILLS FOR HANDLING AND STORAGE OF RICE HUSK AND HANDLING, STORAGE & DISPOSAL OF BOILER ASH

Rice husk is the largest by-product of rice milling industry which amounts to 22-24 percent of the total paddy. The units need to handle the bulk quantities of husk and store them within the unit premises till husk is used or sold. The following practices are generally followed for rice husk handling and storage:

4.1 Handling of Rice Husk

i) From de-husker machine to storage

During the milling of paddy, rice husk is separated out in the de-husker machines and husk is sent to storage yard in many ways depending upon the mill scale, type and mechanism employed:

- **Using blowers**

In most of the small mills husk from de-husker is simply blown to storage yard with help of blowers as shown in figure 4.1 and 4.2.

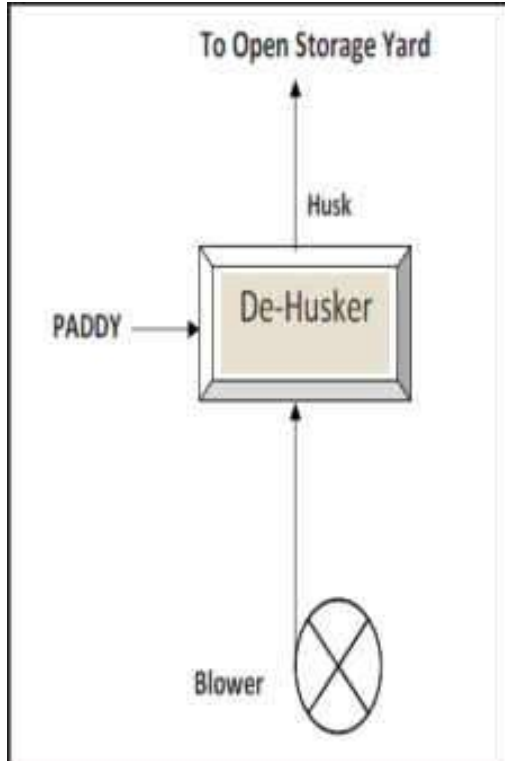

Fig 4.1-Husk Blown to Open Storage Yard Small-scale mills



Fig 4.2-Husk Handling in Small-scale mills

- Using Conveyor-belt system & Cyclones for dust extraction

In most of the large mills the husk is extracted from aspirators and it is collected on the conveyor belt. From conveyor belt the husk is conveyed to the storage yard (shown in figure 4.3, 4.4 and 4.5).

The units also have dust extraction system in the aspirators and other machinery of milling section connected to cyclone for fine/dust collection.

From extraction system, the fines/dust is taken to cyclone from where the dust/fines separate out and falls from the bottom of cyclone. But major portion of the Fine Particles not collected in cyclones, escape to atmosphere from discharge of the Induced Draft Fan.

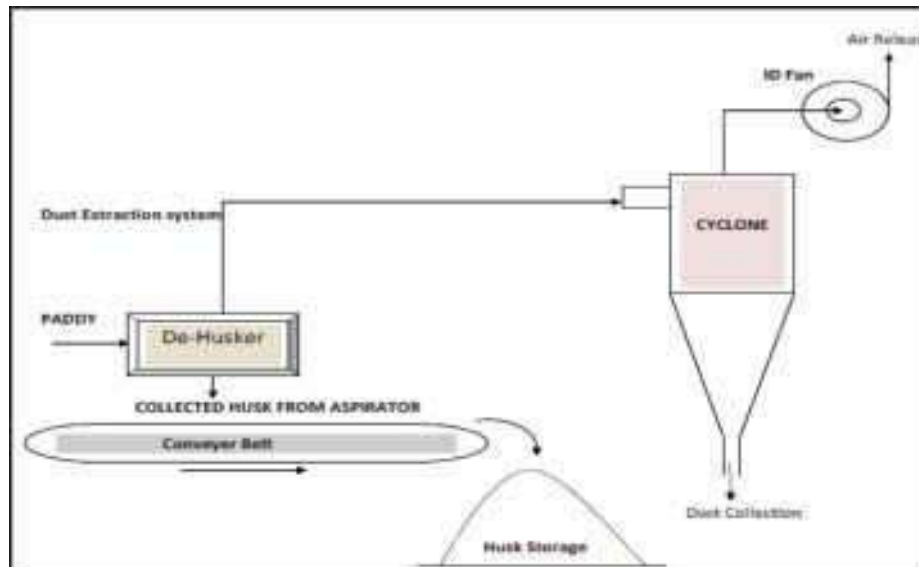

Fig 4.3-Husk Handling in Large-scale mills



Fig. 4.4- Dust extracted through Cyclone



Fig 4.5-Rice husk conveyance in storage yard using conveyor belts Conveyor Belt

ii) Storage of Rice Husk

The husk generated during milling is taken to storage yard. Most of the small units have a common open storage of rice husk, rice bran and also the dust collected by the Paddy Cleaner. The units have different practices for storing the rice husk like fully open storage with boundary wall, partially covered storage and completely covered storage as discussed below:

- a) **Fully Open Storage with boundary walls:** Most of the small and medium units store the rice husk in open area within their premises. However, most of the small and medium mills have 10 foot boundary wall surrounding the husk storage areas as shown in figure 4.6., to reduce wind movement and to reduce dust carryover due to wind.



Fig 4.6-Rice husk storage in fully open area with boundary walls

Generally the storage areas available are not adequate and large heaps of rice husks could be seen rising above the boundary wall height in many of the mills. The small mills extend and divert the length of pipe which blows husk within certain distance in the storage yard, keeping in mind all the specifications of the blower so as to ensure that the pressure doesn't drop below a certain value in the pipeline & husk is blown smoothly out into the storage area, which results in formation of rice husk heaps (as shown in figure 4.7).

Periodically, as the height of a heap increases, flattening of the peak of the heap is done manually by pushing the Husk to sides. Typically, the storage is done in the area between the boundary walls and the factory shed wall.

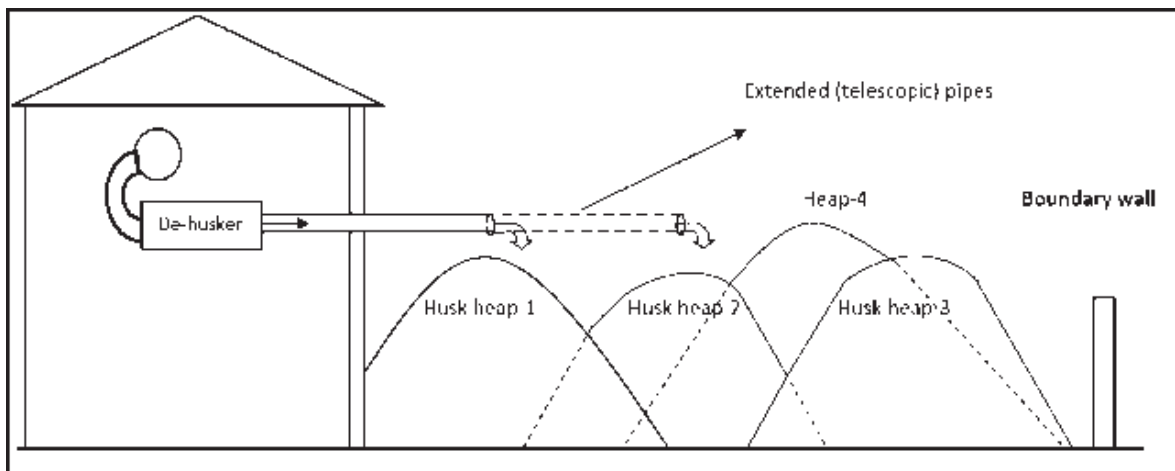



Fig 4.7-Heaps of rice husk in the fully open storage area with extended pipes

b) Open Storage without separating fines: In most of the small mills the husk from de-husker is simply blown to storage yard with help of blowers without separating fines. Therefore the stored husk in these mills has more percentage of fines which gets airborne during windy period.

c) Open Storage with fines partially separated by cyclone: In most of the medium and large mills the husk from de-husker is separated with help of cyclone and fines are released to atmosphere from Cyclone discharge end. In this case the stored husk has less percentage of fines.



Fig 4.8-Fully open storage of rice husk without separating fines

d) Common open storage of husk and rice bran fines: Many small mills do not separate fines & rice bran from the husk and have common storage of husk with fines and bran.

e) Partially covered storage using fencing:

Most of the large units have covered their husk storage areas partially with tall fencing, to combat with large quantity of stored husk and to reduce the fugitive emissions from the storage yard. The figure 4.9 shows the storage of large quantities of rice husk with tall fencing.



Fig 4.9-Large quantities of husk storage with tall fencing

f) Covered storages: Few medium and large units have covered storage yards for storing rice husk. Figure 4.10 shows a closed room where separated husk from milling section is stored. The storage of rice husk in closed space eliminates the possibility of fines blowing with the wind besides reducing the fugitive emissions.

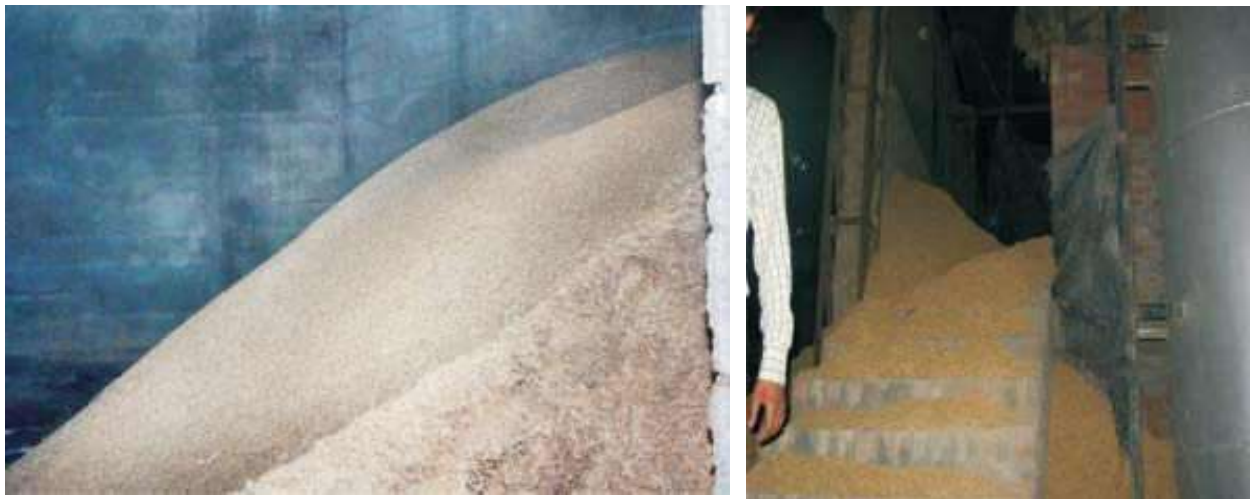

Fig 4.10-Rice husk storage in closed room

iii) Handling from Husk Storage to boiler

Most of the medium and large mills use covered conveyor belts (mechanical system) for handling husk from storage area to boiler as shown in figure 4.11. However, some small units also handle the husk manually for utilization in the boiler. Most of the small, medium and large mills manually level the husk heaps in storage yard.



Fig 4.11-Husk Handling from storage yard to boiler using conveyor belts in large mills

iv) Handling during loading for transportation and selling

Rice Husk is used as a fuel in Boilers in large, medium as well as small mills. Whereas, most of the small units which are making only Raw Rice have no utilization of Rice Husk. In these units, Rice Husk is sold to the contractors for use as a Boiler Fuel of Rs. @ 3-5/kg. The husk is loaded in the trucks manually with the help of shovels and sent to the market as shown. Figure 4.1.2. In large unit, there is complete utilization of Rice Husk as Boiler Fuel whereas in Medium and Small unit some of the extra/unutilized Rice Husk is sold.

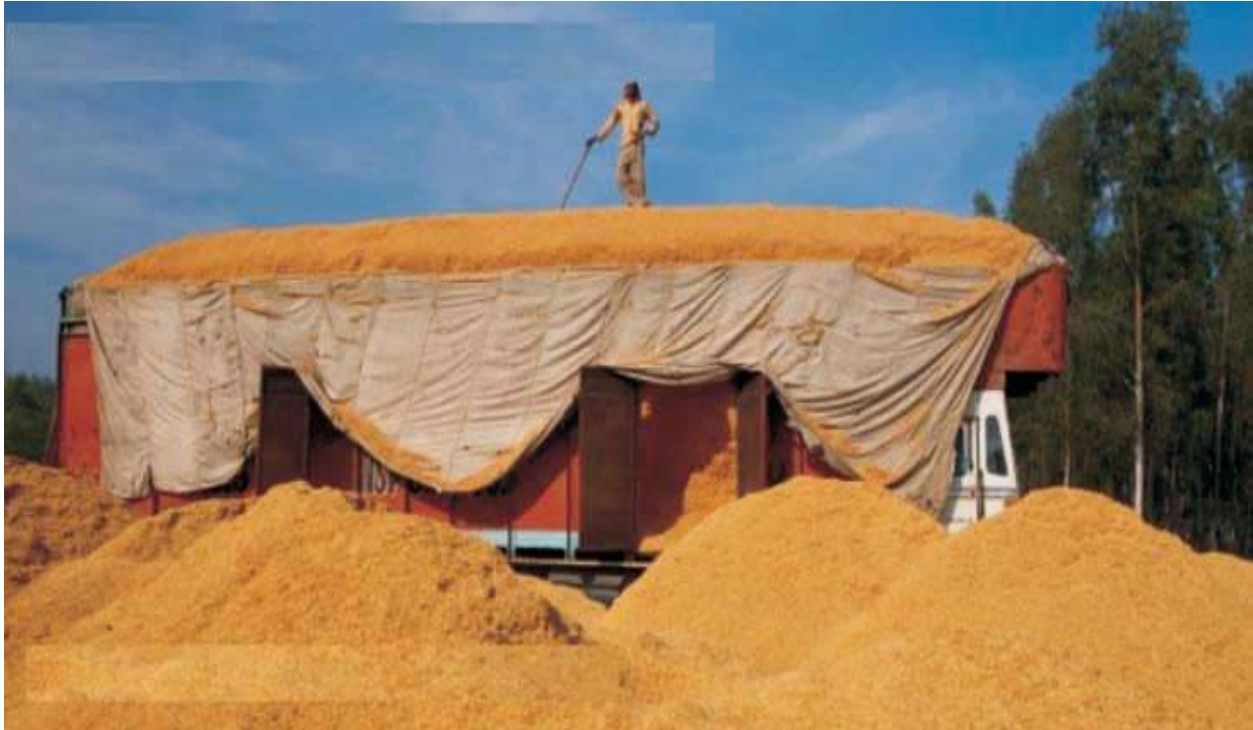

Fig 4.12- Husk loading for transportation & selling

4.2 Practices for handling, Storage and disposal of rice husk fired boiler ash

Most of the parboiled units use the rice husk as boiler feed for steam generation and for electricity generation in captive power plants. After the combustion of rice husk in boiler the boiler ash is generated which needs to be handled, stored and disposed off properly to reduce the environmental pollution in and around rice mills. The rice mills generally follow the following practices for handling, storage and disposal of ash generated from rice husk fired boiler.

4.2.1 Handling of rice husk fired boiler ash

Most of the medium and large scale units handle their boiler ash mechanically and collect it in the trucks/trolley, directly from boiler, with the help of conveyor belt and hoppers as shown in figure 4.13. They also spray water over the collected ash in trucks and nearby boiler section to reduce the fly ash emissions. The Small Scale Rice Mills having small size Boilers generally handle the Boiler Ash manually, during collection from Boiler Section to Temporary Storage.



Fig 4.13-Mechanical handling of boiler ash

4.2.2 Storage of rice husk ash

A large quantity of boiler ash is generated in the parboiled rice mills which need to be stored temporarily before its disposal. Generally the following practices are followed for boiler ash storage and disposal:

- **Open Storage**

Most of the small & medium rice mills have open storage of boiler ash within the unit premises as shown in figure 4.14.



Fig 4.14-Open storage of husk fired boiler ash

- **Partially covered storage**

Many of the small & medium rice mills store their boiler ash in partially covered storages. Figure 4.15. depicts the Ash generated from the Furnace on the left.



Fig 4.15-Partially covered storage of husk fired boiler ash

- **Limited Closed storage of APCD collection**

Many of the large and medium units store their boiler ash (collected by APCD's, like Cyclones, Multicyclones, etc) in closed rooms where it is stored temporarily before their disposal as shown in figure 4.16.



Fig 4.16-A Closed storage of husk fired boiler ash

4.2.3 Disposal of rice husk fired boiler ash

- **Disposed in own land-fill sites, by Large Mills.**

Most of the large units dispose their boiler ash on part of their own land, converted as landfills (Figure 4.17). After disposal of boiler ash on the land it is covered with a layer of soil and plantation developed over. Recycled wastewater is periodically sprinkled on the ash disposal site to avoid wind blowing of fly ash in the nearby areas.



Fig. 4.17 - Boiler ash Disposal land-fill site



Fig 4.18-Layer of soil after disposal of boiler ash



Fig 4.19-Plantation in the boiler ash disposal site

- **Disposal through Ash Contractors for disposal in low-lying areas**

Most of the small and medium mills not having their own disposal facilities generally dispose their husk ash, through contractors, who dispose it to available low lying areas. Most mills give this job on contract basis where the contractors collect the boiler ash from the unit premises and dispose it on payment basis. In this case even the generator of ash is not aware of the ultimate disposal site of its boiler ash.

In the areas where use of boiler ash is common in fields by farmers, the mills or contractors also sell boiler ash for use in the farms. Limited amount of ash is required for conditioning and stabilization of poor soils in fields. As only a small quantity is required, therefore, farmers buy only some percentage of the boiler ash as per their requirement.

FUGITIVE EMISSIONS AND ENVIRONMENTAL ASPECTS IN RICE MILLS

5.1 Sources of Fugitive Emissions in Rice Mills

In rice mills fugitive emissions are generated from various sections during handling of paddy; cleaning & milling of paddy; handling and storage of husk and handling, storage and disposal of boiler ash due to various activities in the mills. Brief description of sources of fugitive emissions are given below and also discussed in table 5.1.

1. Fugitive Emission during handling of Paddy from Unloading to Silo.

- During Unloading of paddy (cutting open the Gunny bags and releasing Paddy)
- At different stages of lifting and discharging of paddy rice through bucket elevator
- Transfer points (belt to belt; belt to elevator; elevator to silo)
- Storage Bins (emissions from top of Silo, as Paddy is discharged by Bucket Elevator)
- Locations of free fall of paddy (fine dust getting airborne due to free fall)

2. Fugitive Emission during Cleaning of paddy:

- During pre-cleaning (mostly in Rotary Drums- fines separated due to movement and free fall of Paddy)
- During paddy cleaning in paddy cleaner/ vibrating screen (due to rigorous movement of paddy, fines are generated)
- De-stoner machines (fines get extracted)
- Final cleaning in Paddy cleaners (fines are extracted out).



Fig 5.1-Paddy Unloading



Fig 5.2(a)-Bucket Elevator
Fig 5.2(b) Conveyer



Fig 5.3-Silo



Fig 5.4-Paddy Cleaner



Fig 5.5-Vibratory Screens

3. Fugitive Emissions during Milling of paddy

- At different stages of lifting and discharging of paddy /rice through bucket elevator (fines get airborne due to movement, fall of Paddy/ Rice)
- During dehusking of paddy in Hullers (fines are generated due to breaking of Paddy)
- At Aspirators used for husk removal (fines are extracted)
- During polishing of rice (fines are generated due to polishing)
- During grading of rice in rice grader (fines carried along with rice)



Fig 5.7-De-huskers



Fig 5.6-Conveyer & BE



Fig 5.9-Aspirators



Fig 5.8-Polishers & Graders

4. Fugitive Emissions from Handling & Storage of Rice Husk:

- During conveying of Rice Husk from milling section to husk storage area (Unseparated fines are blown along with Husk)
- At Rice Husk Storage area (fines get airborne due to wind currents)
- During Conveying and Handling of Rice Husk to Boiler Section (fines contained in the dry husk, get airborne during transport/ conveying & free fall of Husk)



Fig 5.10-Rice Husk Storage Areas and conveyance systems

5. Fugitive Emissions of Fly Ash in the Boiler Section:

- Through leakages in the ducts/flanges from boiler to stack (fines escape to atmosphere)
- Fall of coarser Boiler Fly Ash from Stack (coarser Fly Ash particles fall on ground in the vicinity of Stack)
- From temporary Ash Storage (fugitive emissions due to wind blowing of Fly Ash temporarily stored at site)



Fig 5.11-Boiler section and ash generation

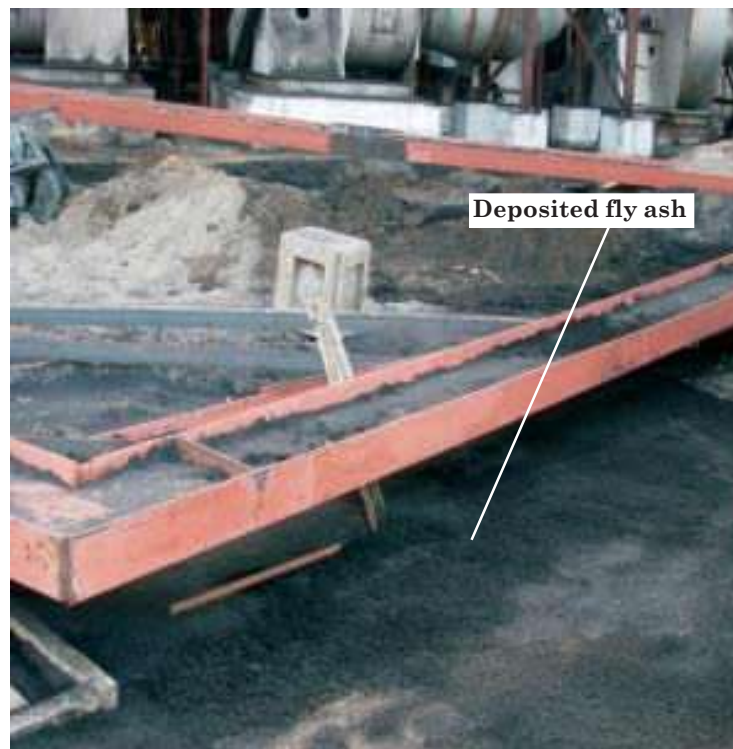

Fig 5.12-Fly ash deposited on ground near boiler section due to Fugitive Emissions

6. Fugitive Emissions from temporary Ash Storage and Disposal areas:

- Boiler ash conveyance from boiler to trolley (carryover of Fines during conveyance, free fall of Ash)
- From open temporary ash storage area (fines get airborne due to wind currents)
- From uncovered and unprotected disposal sites (as the moisture dries away, or top soil layer gets removed, fines in the dry Ash get airborne due to wind currents)



Fig 5.13-Fugitive Emissions from Boiler Ash temporary storage area



Fig 5.14- Re-entrainment of boiler ash particles from unprotected dry disposal sites

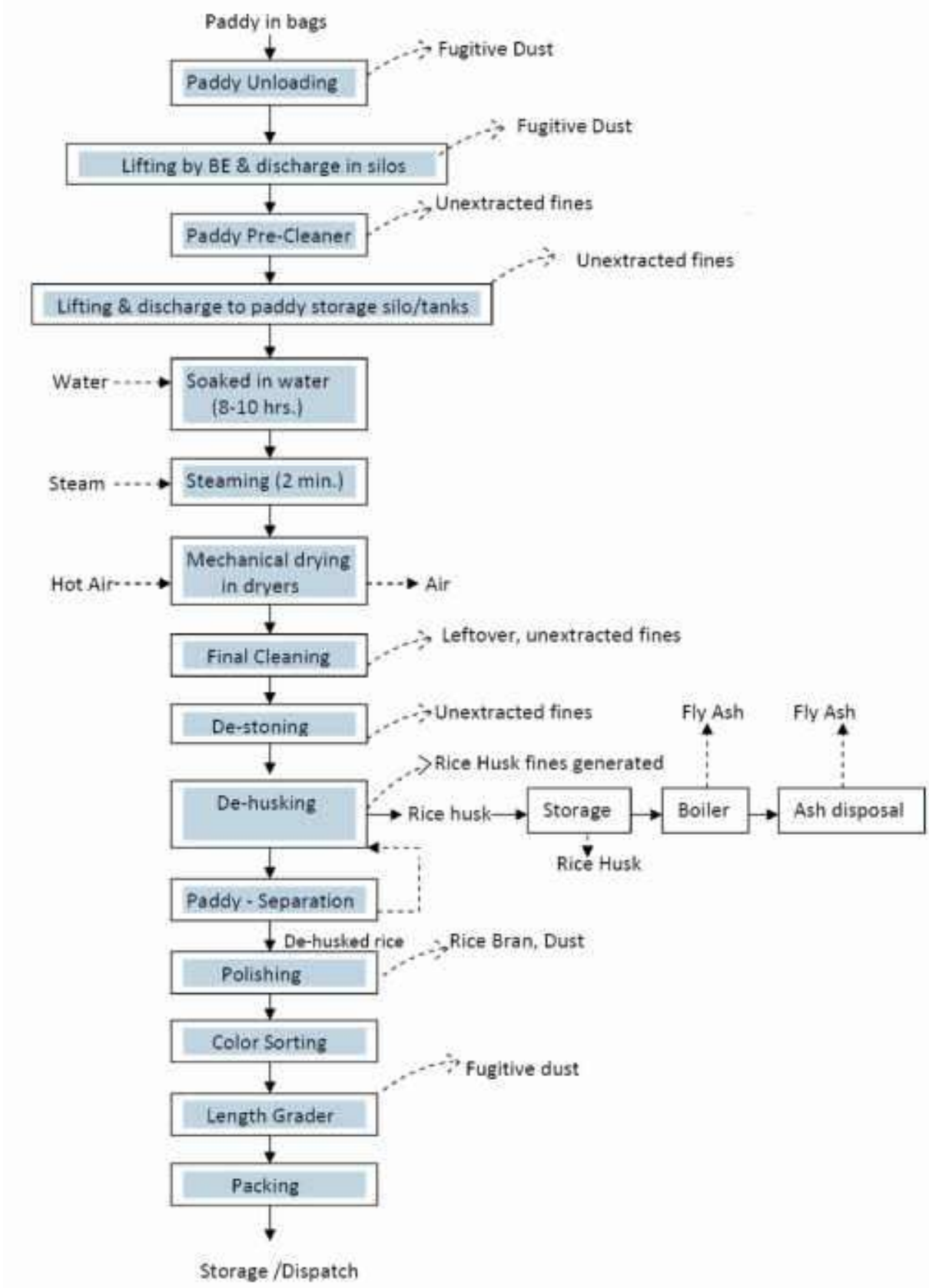

Fig 5.15-Typical Fugitive Emission Sources in Rice Mills

Table 5.1: Typical Sources of Fugitive emissions in Rice Mills

| S.NO. | SECTIONS | SOURCES OF FUGITIVE DUST EMISSIONS | TYPE OF FUGITIVE EMISSIONS |
|-------|-------------------------------|---|----------------------------|
| 1. | UNLOADING SECTIONS | a) Paddy Unloading | Fugitive Dust |
| | | b) Bucket Elevator | Fugitive Dust |
| | | c) Transfer points <ul style="list-style-type: none"> • Belt to belt • Belt to elevator • Elevator to silo | Fugitive Dust |
| | | d) Paddy storage Bins | Fine Dust |
| | | e) Locations of free fall of Paddy | Fine Dust |
| 2. | CLEANING SECTION | f) Pre- Cleaner machine | Unextracted Fines |
| | | g) Vibratory screen | Fine Dust |
| | | h) De-stoner | Unextracted fines |
| | | i) Paddy cleaner | Fine Dust |
| 3. | MILLING SECTION | j) Bucket Elevator | Fine Dust |
| | | k) Hullers/ De-huskers | Rice husk fines generated |
| | | l) Paddy Separator/ Aspirator | Fine Dust |
| | | m) Polishers | Rice Bran Dust |
| | | n) Grader | Fugitive Dust |
| 4. | RICE HUSK HANDLING & STORAGE | o) Conveyers | Fine Dust, Rice Husk |
| | | p) Rice Husk Storage Area | Fine Dust, Rice Husk |
| 5. | BOILER SECTION | q) Leakages from ducts and flanges from boiler to stack | Fly ash |
| | | r) Ash Conveyers | Fly Ash |
| 6. | ASH STORAGE AND DISPOSAL SITE | s) Open Ash Storage | Fly Ash |
| | | t) Ash loading and unloading | Fly Ash |
| | | u) Unprotected Ash disposal site | Fly Ash |

5.2 Fugitive Emission Control Systems Adopted by Rice Mills

The raw paddy received by the mills commonly contains fine dust and long fibers shaped particles carried from Paddy fields. This Fine dust includes partly the soil contents in which the paddy was grown and other fine particles. During rice milling fine dust is generated, like Rice Husk fines, Rice Bran fines, etc. In order to improve the work environment and control the fugitive emissions from various sections (i.e. Unloading, Pre-Cleaning, milling, Boiler etc.) most of the rice mills have employed various dust extraction cum control systems as discussed below.

5.2.1 Unloading and Conveying Section

In most of the large, medium and small rice mills substantial amount of dust is generated during unloading to storage section. Dust sources include Conveyers, Transfer Points, Silos and Bucket Elevators. However various mills have adopted different fugitive emission control system in the unloading and conveying section as discussed below.

| CONTROL SYSTEMS ADOPTED | |
|---|--|
| Large & Medium Scale Mills | Small Mills |
| Suction Ducts and Hoods at Bucket Elevators and Conveyers, Suction Hood at unloading area, etc as shown in figure below | No such dust extraction systems are present in many small mills. |



Fig 5.16-Extraction Hood near Bucket Elevator in large mills

5.2.2 Paddy cleaning Section

Typically the emissions from the cleaning section comprise of dirt, dust, fibers etc. in huge quantity. This dirt is generated in the Vibratory Screen/ Paddy Pre-Cleaner. Various extractions cum control systems adopted in large medium and small mills are discussed below.

| CONTROL SYSTEMS ADOPTED | |
|---|--|
| Large & Medium Scale Mills | Small Mills |
| <p>Few of the Large Mills employ Cyclone cum Bag-filter type arrangement in the Pre-cleaning section for collection of Coarse and Fine Dust respectively as shown in figure 5.17. Whereas most of the medium scale mills employ only Cyclones for collection of Dust.</p> | <p>Generally employ an ID Fan for extraction of Dust from various equipments. Typically, several flexible pipe connections are taken from the main pipe entering the ID Fan (shown in Fig. 5.18 below). The extracted air is passed through a Cyclone, where coarse particles are collected and the fines are discharged through a Stack placed above Cyclone.</p> |

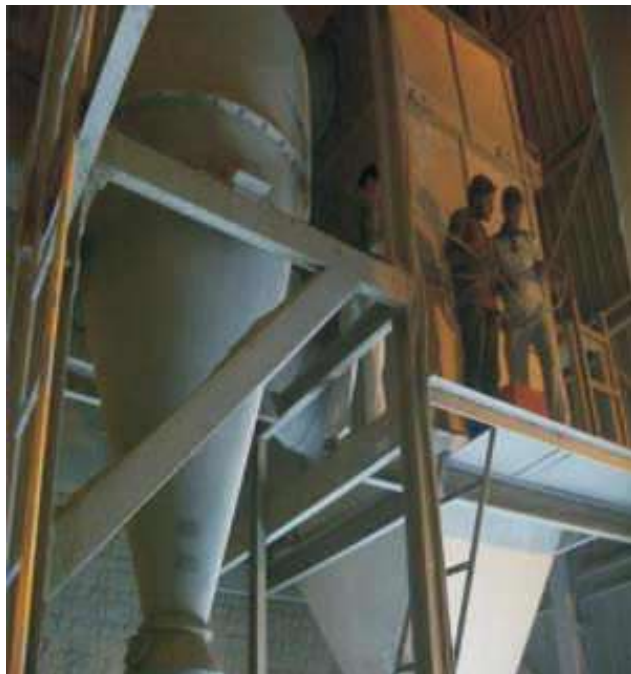

Fig 5.17-Cyclone followed by Bag Filter at Pre-Cleaner in large mills



Fig 5.18-Variou flexible suction pipes sucking from various equipments and passed through a common cyclone in small rice mills

5.2.3 Milling Section:

Emissions from milling section comprise of Fine Dust, Rice Husk fines and Rice Bran generated at distinct stages of milling and their control systems are discussed below:

| CONTROL SYSTEMS ADOPTED | |
|---|--|
| Large & Medium Scale Mills | Small Mills |
| Nearly all Large mills possess proper extraction systems with ID Fan arrangement as shown in figure 5.19. Most of the mills employ only Cyclones for control of Dust extracted from Hullers, Paddy Separator and Polishers. | Most of the Small Mills have flexible Suction Ducts for extraction of Dust, Rice Husk fines and Rice Bran as shown in figure 5.20. For separation and collection of fines generally Cyclones are installed (shown in figure 5.21). |



Fig 5.19-Proper dust extraction system with cyclone and ID fan in Large mills



Fig 5.20-Variou suction ducts from milling section to a common cyclone in small rice mills



Fig 5.21-Suction ducts from polisher to cyclone for bran separation in small rice mills

5.2.4 Boiler Section

In boiler section fugitive emissions mainly occur through leakages in the ducts/flanges from boiler to stack. The dust control systems adopted by mills in the boiler section are as follows:

| CONTROL SYSTEMS ADOPTED | |
|--|---|
| Large & Medium Scale Mills | Small Mills |
| Most of the Large and Medium scale Mills employ Cyclones and Multi-cyclones for collection of Bottom Ash in the Boiler Section. Generally partial enclosure is provided. | Ash generated in Furnace is manually taken out in pits. |



Fig 5.22- Cyclone for collection of boiler ash in large and medium rice mills

5.2.5 Rice Husk Handling and Storage Section:

In most of the mills Rice Husk is stored openly surrounded by walls in order to control the fugitive emissions. Closed rooms are also provided by units for storage of Rice Husk to control the emission of rice husk fines.

5.2.6 Ash Handling and Disposal Site

Many medium and large mills spray water in the boiler ash handling sections to suppress the fly ash. Ash is loaded and conveyed to open Landfills in wet form in order to control fugitive emissions and is also covered with a fine layer of soil at the disposal site for the same purpose.

A schematic diagram highlighting various types and locations of fugitive emission control system in small and large/medium mills are shown below in figure 5.23 and 5.24:

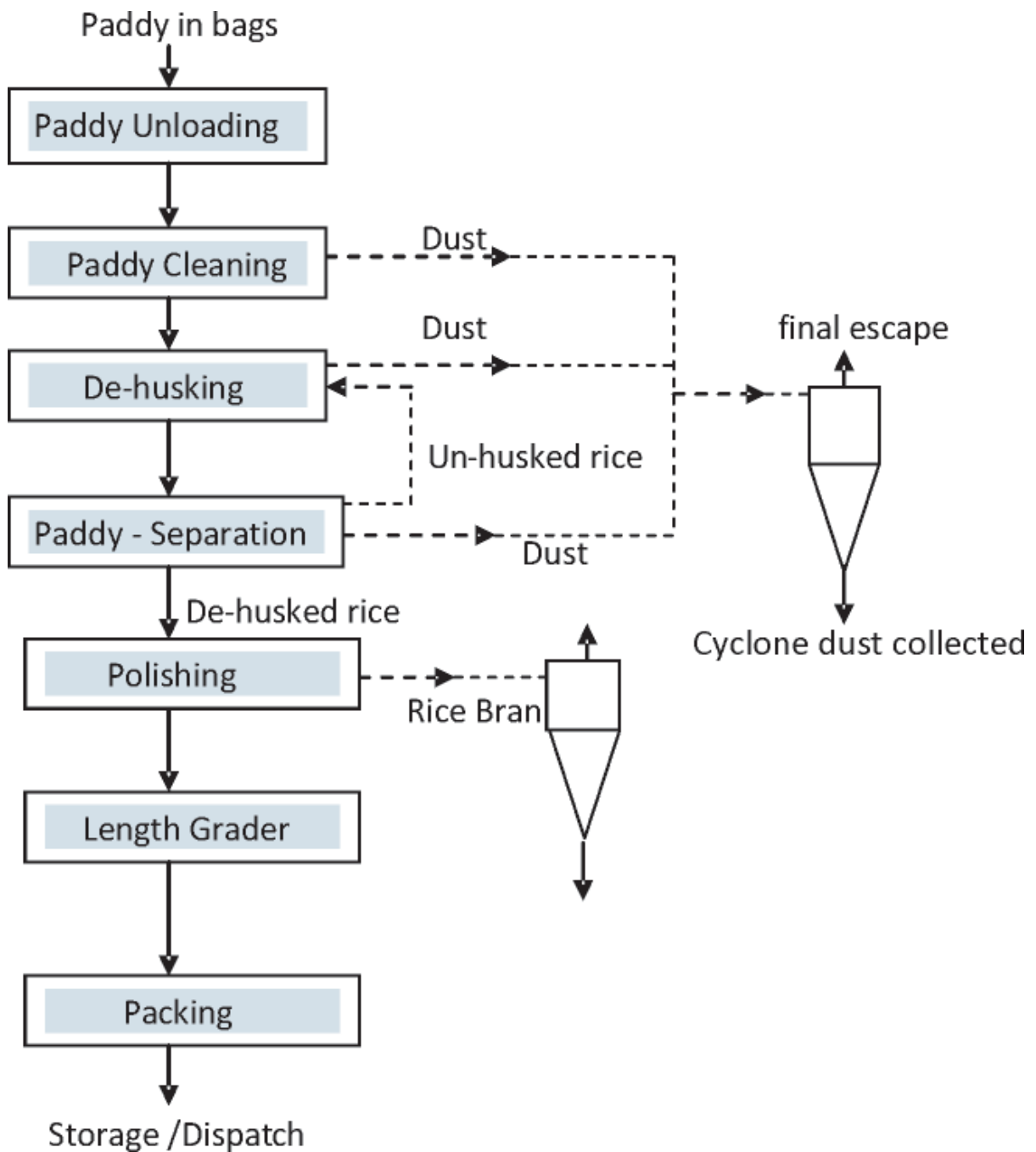

Fig.: 5.23 Dust Extraction cum Control Systems Adopted in Small White (Raw) Rice Mills

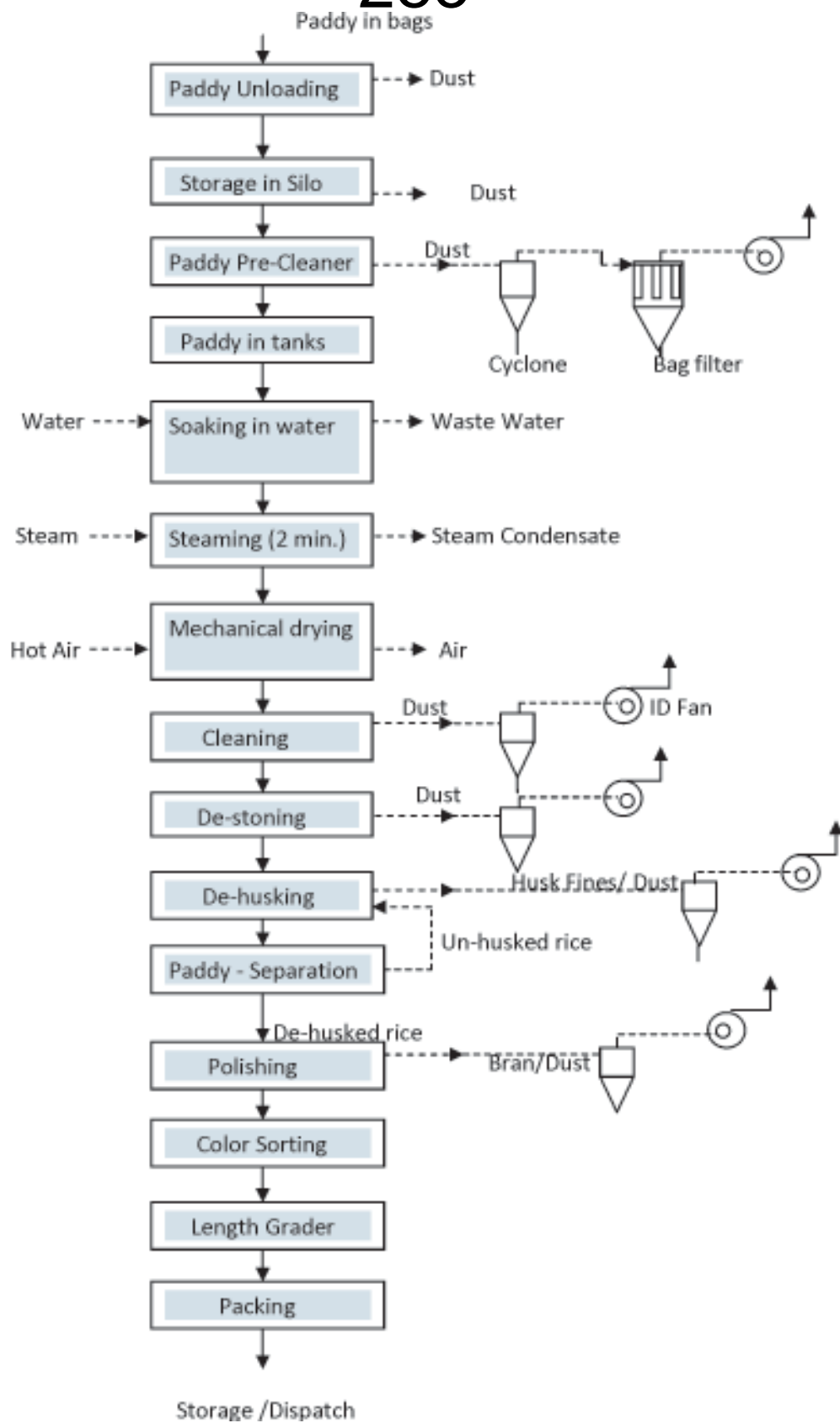

Fig. 5.24 EXTRACTION CUM CONTROL SYSTEMS ADOPTED IN LARGE & MEDIUM SCALE MILLS

5.3. Overall Observations on Fugitive Emissions:

In regard to fugitive emission controls following observations were made:

5.3.1 Unloading and conveying area

- Substantial amount of dust is generated at the unloading section. Dust sources include conveyers and bucket elevators.
- There are no effective control devices to capture the dust at transfer points. Dust escapes during free fall of Paddy and various conveying points.
- Some mills practice unloading of Paddy in closed rooms whereas some it in open.

5.3.2 Cleaning section

- Typically the emissions from the cleaning section comprised of dirt, dust, etc. carried from agriculture field along with the raw material.
- The Pre- cleaning section had Cyclone cum Bag-filter type arrangement in few of the Large Mills and others had only Cyclone. Still there was high level of fugitive emissions observed at the pre-cleaning section. This shows that the dust extraction systems employed in most of the mills are poorly designed and working inefficiently, due to lack of maintenance, choking of ducts, inappropriate quantities of air extracted, etc.
- Dust generated at the pre-cleaning section could be seen deposited on the floors, walls and control devices.
- However, most of the small mills do not possess proper extraction systems at Paddy cleaner. They possess a common cyclone for all the Milling operations. It was observed that the fines generated at the Paddy Cleaner were spreading in the environment.

5.3.3 Milling Section

- It was observed that fugitive emissions arise at various stages of lifting and discharging of Paddy as well as in the Milling Section at Huller, Paddy separator, Polishers, etc.
- It was seen that nearly all Large and Medium scale mills employ individual Cyclones for control of Emissions at Hullers, Paddy Separator and Polishers. Most of the mills possess extraction systems having Cyclone cum ID Fan arrangement.
- However, most of the Small Mills possess only Blowers or Flexible Suction Ducts for extraction of Dust, Rice Husk fines and Rice Bran. But for collection of fines most of the small units have Cyclones.
- Many of the small mills possess common cyclone for cleaner, de-husker and paddy separator. Ducts from all these machines combine at the inlet of ID Fan.

5.3.4 Rice Husk Storage and Handling site

- It was observed that Fugitive emissions occur at various stages of lifting and handling of husk as well as during its conveying to the Boiler section.
- Most of the small mills had Common area for Open Storage of Rice Husk, Rice Bran and Fines generated in the Milling Section. The fines generated are blown away by the wind leading to Fugitive Emissions in the surrounding environment.
- In most of the small mills the husk from de-husker is simply blown to storage yard with help of blowers. Moreover, huge heaps of Rice Husk could be seen in these small mills rising beyond the boundary wall height indicating excessive storage.
- The Large and Medium Mills possess semi-closed Storage system for Rice Husk. Storage is either closed or surrounded by Fine Mesh Walls.

5.3.5 Ash Handling and Disposal site

- It was observed that fugitive emissions occur at the Ash Handling and Discharge point near the Boiler Section.
- Few of the Mills store the Ash generated in open area.

CHARACTERIZATION AND QUANTIFICATION OF POLLUTANTS AND FUGITIVE EMISSIONS IN RICE MILLS:

6.1. Field Measurements Conducted:

Monitoring of emissions was carried out in selected 7 representative units as shown in Table 6.1. For monitoring purpose three parameters were considered – Fugitive Emissions Assessment, Stack Monitoring and Ambient Air Quality Monitoring. In order to evaluate and quantify the air pollution problem, measurements were carried out for selected air pollutants.

Fugitive Emission Assessment was carried out at Pre-cleaning Section, Milling Section and Boiler House. In Milling Section, Stack Monitoring was done at inlet and outlet of Paddy Cleaners, De-huskers, Aspirators, Polishers, etc as well at the Inlet and Outlet of Cyclones and ID Fans. Stack Monitoring was carried out in Rice Husk fired Boiler House, at Stack.

Table 6.1 Type of Monitoring carried out in 7 representative units.

| Unit Code | Milling Capacity | Scale of Operation | Type of Process Employed | Type of Monitoring carried out |
|-----------|------------------|--------------------|-------------------------------------|---|
| 1 | 55 tonne/hr | Large | White (Raw) Rice & Parboiling both | Fugitive Emissions Assessment, Stack Monitoring, Ambient Air Quality Monitoring |
| 2 | 3 tonne/hr | Small | White (Raw) Rice Mill | Fugitive Emissions Assessment, Stack Monitoring, Ambient Air Quality Monitoring |
| 3 | 1 tonne/hr | Small | White (Raw) Rice Mill | Fugitive Emissions Assessment, Stack Monitoring |
| 4 | 12 tonne/hr | Medium | White (Raw) Rice & Parboiling both. | Fugitive Emissions Assessment, Stack Monitoring |
| 5 | 2 tonne/hr | Small | Parboiled mill | Fugitive Emissions Assessment, Stack Monitoring |
| 8 | 2 tonne/hr | Small | Parboiled Rice | Stack monitoring, Fugitive Emissions Assessment |
| 11 | 2 tonne/hr | Small | Parboiled Rice | Stack Monitoring, Fugitive Emissions Assessment |

6.1.1 Equipments used for Emission Monitoring:

- Equipments used during Stack Monitoring comprised of Digital Thermometer, Inclined Manometer, U-tube Manometer and Stack Monitoring Kit.
- Digital Thermometer was used to measure ambient temperature and Stack Gas Temperature.
- Velocity measurement was done using Inclined Manometer (as shown in fig. 6.1)
- Static Pressure and Pressure Drop were measured using U-tube Manometer.
- Particulate Matter Sampling was done using Stack Monitoring Kit (as shown in Fig. 6.2.)
- Ambient Air Quality Monitoring and Fugitive Emissions Assessment were done using High Volume Samplers (as shown in Fig. 6.3.)



Fig. 6.1 Inclined Manometer used for Velocity Measurement



Fig. 6.2 Stack Monitoring Kit



Fig. 6.3 Respirable High Volume Sampler

6.1.2 Procedure for carrying out Emissions Monitoring:

1. Ambient Air Quality Monitoring:

24 hours Sampling was done for Ambient Air Quality Monitoring. Selection of monitoring locations, monitoring and analysis of various parameters of interest was conducted according to the CPCB guidelines.

- i. **Identification of Monitoring Stations:** After a preliminary reconnaissance of the study region and taking into account the meteorological conditions, sites were identified for Air Quality Monitoring.

The criteria followed for selecting the monitoring sites as per CPCB regulations were as follows:

- The sampling station had free exposure so that it did not collect air from stagnant pockets.
- It was not obstructed by large structures.
- The sampling point was not directly influenced by any local sources of emissions.
- It was located at a minimum height of 3 m from the ground level.

- ii. **High Volume Sampler:**

- The high volume filtration method is popular for measurement of the mass conc. of suspended particulate matter smaller than 50 μm . A known volume of air is sucked by high speed blower through a fine filter and the increase in weight due to trapped particles is measured.
- **Respirable Dust Sampling -** Ambient air laden with suspended particulates enters the system through the inlet pipe. As the air passes through the cyclone, coarse, non respirable dust is separated from the air stream by centrifugal forces acting on the solid particles. These separated particulates fall through the cyclone's conical hopper and are collected in the sampling bottle placed at its bottom. The fine dust forming the respirable fraction of the Total Suspended Particulates (TSP) passes through the cyclone and is carried by the air stream to the filter paper clamped between the top cover and filter adaptor assembly. The Respirable Dust is retained by the filter and the carrier air exhausted from the system through the blower.

- iii. **Gaseous Pollutants Sampling:**

- Absorption of gaseous pollutants into a liquid medium is probably the most commonly employed method of collection of gaseous matter. The basic properties of various gaseous pollutants are used to absorb them in suitable chemical reagents.
- Absorption separates the desired pollutant from air through direct solubility in the absorbing medium.
- In the impinger, the gas stream is impinged at high velocity onto a flat surface thus providing good contact between the gas and the liquid.

- A filtered sample of flue gas is bubbled through an impinger train at a metered flow rate. The impingers filled with appropriate reagents absorb the gases of interest from the process being monitored.
- The system allows two gases to be sampled simultaneously.
- While the volume of gas sampled is determined from the knowledge of the sampling time and flow rate, concentration of individual pollutants is determined through an analysis of the absorbers.

2. Stack Monitoring:

- i. In Stack Sampler simultaneous sampling for Particulate Matter (PM) and gaseous pollutants can be carried out.
- ii. Flue gases enter the system through the nozzle at the tip of the sampling probe, pass through the FILTER THIMBLE, where particulate matter is removed and carrier air reaches the sampling train/condenser assembly in the instrument panel. Here the gas stream is split into two sections. One section passes at low flow rate (0.5-3 LPM) through a train of impingers loaded with suitable reagents to absorb gaseous pollutants, relevant to the emission source while the remaining gas stream bubbles through a distilled water impinger followed by silica gel. Relatively clean gases then pass through the flow meter and dry gas meter so that the volume of flue gas sampled is measured and are subsequently exhausted into the atmosphere through the vacuum pump.
- iii. Change in weight of the thimble is used to determine the quantity of dust contained in the flue gas sample while a product of the sampling rate and time is used to measure the sample volume. Since particles in motion have inertia, if the PM concentration in the sample drawn from the stack is to truly represent the PM concentration in the stack, ISOKINETIC conditions must be maintained at the tip of the sampling probe. Apparently non- isokinetic conditions tend to cause a separation of particles and gas molecules so that both the concentration and size distribution are altered by non-isokinetic sampling. A standard S- type pitot tube is used to sense the velocity in the stack and the differential pressure produced is measured on a digital/ inclined manometer. A Digital thermometer is used to measure the stack gas temperature. Aerodynamic drag along the stack wall, damper vanes, right angle bends, and side entry ducts etc. cause the flow rate across the cross-section of the duct/chimney to vary. Hence air velocity measurements are averaged out by determining the velocity at different points across the cross-section.
- iv. Since the flow of stack gases varies across the cross-section of the duct/chimney, the particulate concentration too is likely to vary and must be sampled at different traverse points with corresponding change in sampling rate to maintain isokinetic conditions. Therefore, appropriate traverse point need to be fixed where the tip of the sampling probe can be located for obtaining a representative sample. Traverse points are selected based on Standard Protocol (given in Table in Annexure 3).

Data Sheet used for Point Source Emission Monitoring is given in Annexure 4

6.1.3 Monitoring Locations :

UNIT 1 (Code 1):

1. Monitoring at Pre cleaning section:

a) Stack Monitoring at various locations

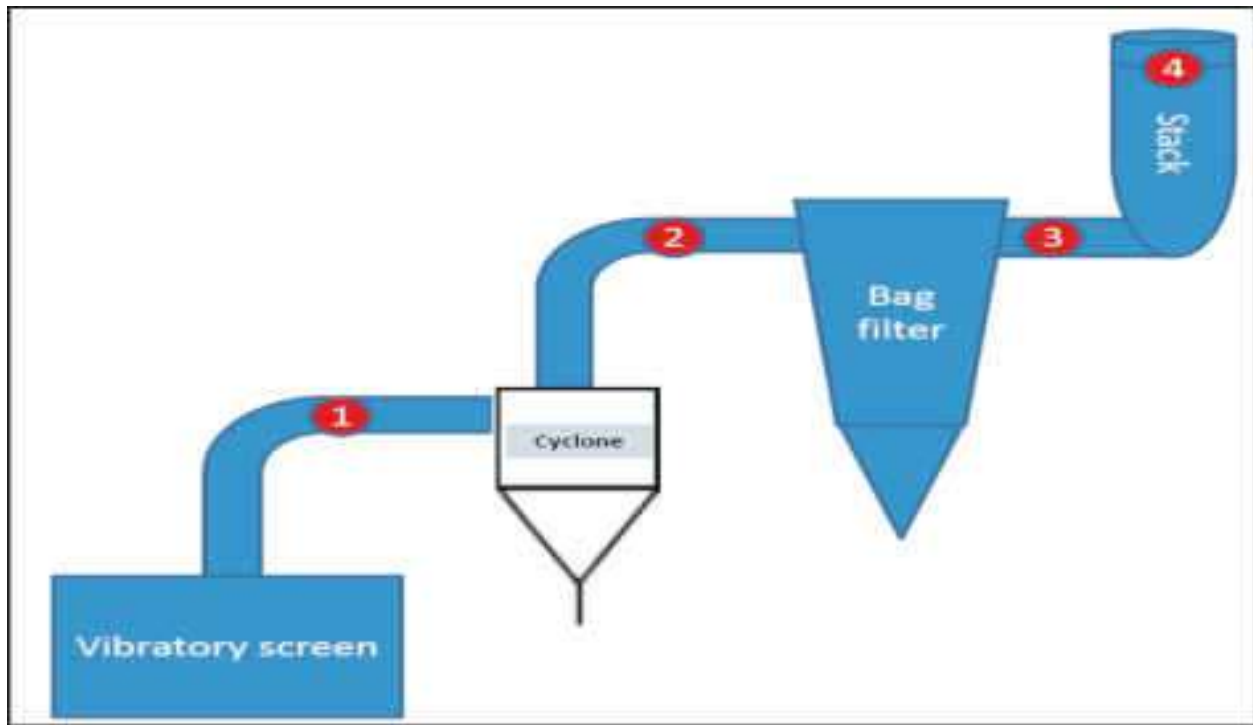

Fig.6.4 Port Hole at Cyclone inlet



Fig.6.5 Cyclone followed by Bag Filter

| MONITORING LOCATIONS in PRE-CLEANING SECTION | | PARAMETERS | | | | | | |
|--|------------------|--------------|--|------------------|----------------|---------------------------------|------------------------|--------------------------|
| | | Diameter (m) | Cross Sectional Area (m ²) | Stack Temp. (°C) | velocity (m/s) | Flow Rate (Nm ³ /hr) | Static Pressure (mmwc) | PM (mg/Nm ³) |
| Location 1 | Cyclone Inlet | 0.65 | 0.33 | 30 | 12.4 | 14495 | -15 | 126.4 |
| Location 2 | Bag Filter Inlet | 0.65 | 0.33 | 30 | 14.6 | 17488 | -68 | - |
| Location 3 | ID Fan Inlet | 0.8 | 0.51 | 30 | 12.2 | 22123 | -290 | - |
| Location 4 | Stack outlet | 0.8 | 0.51 | 30 | 12.2 | 22123 | +14 | 35.7 |

The flow measurements indicate leakages at Cyclone & Bag-filter, as below:

- Leakage volume sucked from cyclone bottom = (17488-14495) = 2993 m³/hr
- Leakage volume sucked through Bag-filter Casing = (22123-17488) = 4635 m³/hr
- **Total Leakage Volume = 7628 m³/hr**

b) Fugitive Emissions Assessment

| MONITORING LOCATIONS | | PARAMETERS | | |
|----------------------|--|--------------------------|----------------------|---------|
| | | TSPM(µg/m ³) | PM 10 | |
| | | | (µg/m ³) | % fines |
| Location 1 | Within cleaning section shed at Ground Floor(5m distance away from screen) | 3699 | 3677 | 99 |



Fig.6.6. Pre- Cleaning Section

Observations: There were substantial fugitive emissions observed which is indicated by the high TSPM measurements. This would be because the dust extraction from some locations was not adequate and therefore only partial dust is sucked by the system, hence, lower dust concentrations in the extracted air.

2. **Monitoring at Milling Section:** A Schematic of Milling Section in Unit 1 comprised of following lay out plan, showing various equipments on various floors along with dust extraction arrangement & ID Fan, Cyclone and Final Discharges:

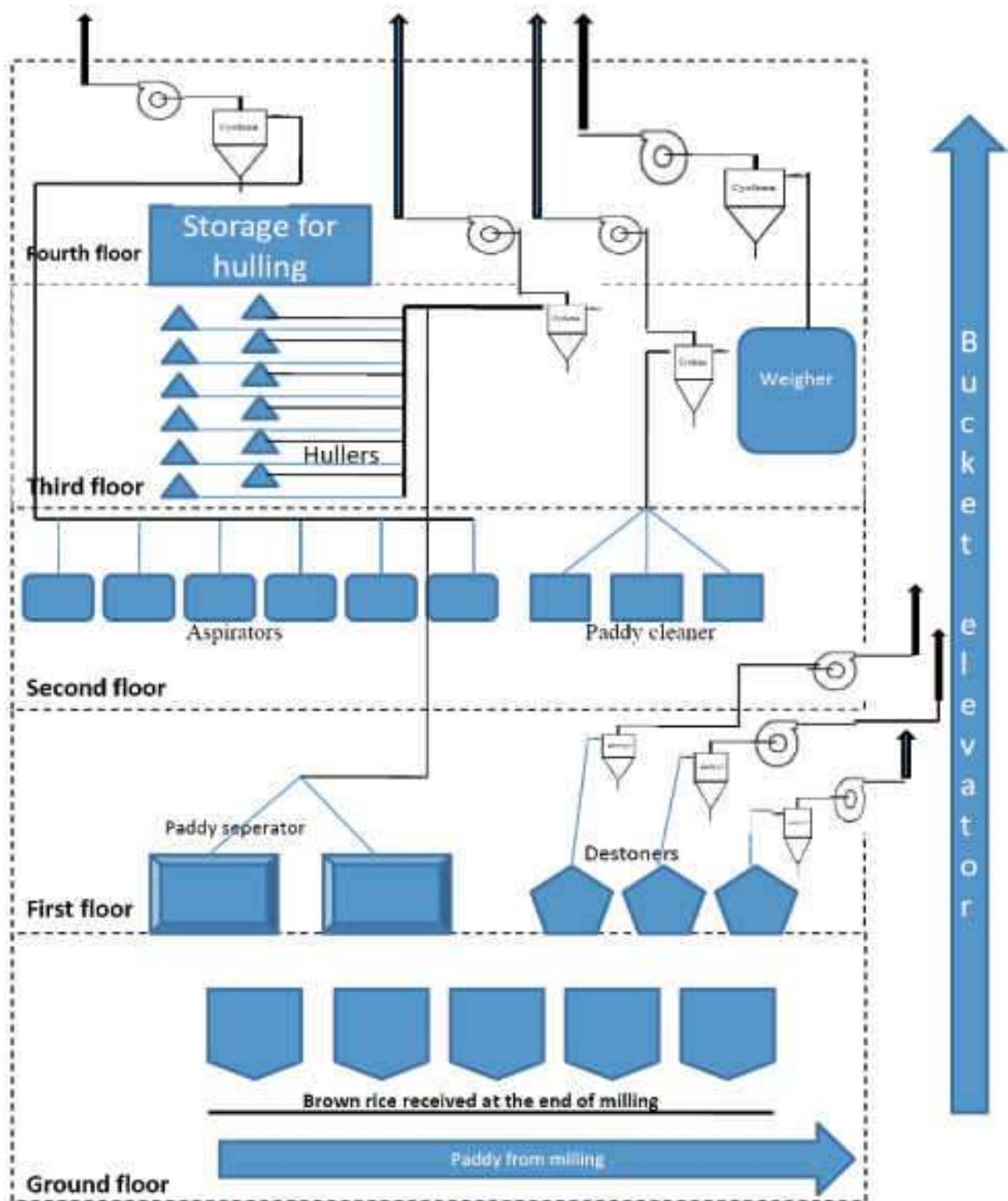

Schematic of the Milling Section showing Locations of Sampling Portholes (1 to 9)

Highlights of Dust Extraction Systems Installed in Milling Sections

| Equipment Extracted | System Component | Port Holes |
|---------------------|--|------------|
| Hullers | Extraction ducts-cyclones- ID fan- stack | 2,3,4,5,9 |
| Paddy cleaner | Extraction ducts-cyclones- ID fan- stack | 1,8 |
| Aspirators | Extraction ducts-cyclones- ID fan- stack | 6 |
| Weigher | Extraction ducts-cyclones- ID fan- stack | 7 |
| Destoners | Extraction ducts-cyclones- ID fan- stack | - |

a) Stack Monitoring:

In the Milling Section, the assessment of volume of air extracted from various equipments and the flow distribution in various branch ducts was done by measurement of velocity, static pressure etc. in various ducts. The measured data is given in the table below.

| Extraction System | Port Hole | Location of Ducts | D(m) | Cross Sec. area (m ²) | TS (°C) | v (m/s) | Flow Rate (Nm ³ /hr) | Ps (mm Wc) |
|-------------------|-----------|---|------|-----------------------------------|---------|---------|---------------------------------|------------|
| Hullers | 2 | Common duct of all Hullers & Paddy Seperator | 0.5 | 0.20 | 30 | 15.5 | 10756 | 42 |
| | 3 | From Paddy Separator | 0.4 | 0.13 | 20 | 10.4 | 4614 | 32 |
| | 4 | Outlet from Single Huller | 0.08 | 0.005 | 30 | 19.7 | 348 | 55 |
| | 5 | Common Outlet from Hulling Section | 0.3 | 0.07 | 30 | 11.7 | 2922 | 45 |
| | 9 | ID Fan Inlet (coming from Hulling Section) | 0.6 | 0.29 | 30 | 11.4 | 11434 | 80 |
| Paddy Cleaners | 8 | ID Fan Inlet (coming from Paddy Cleaning section) | 0.75 | 0.44 | 30 | 12 | 18712 | 27 |
| Aspirators | 6 | Common Outlet from Paddy Separators/ Aspirators | 0.55 | 0.24 | 30 | 7.6 | 6361 | 7 |
| Weigher | 7 | Cyclone Inlet from Weigher | 0.45 | 0.16 | 30 | 8.3 | 4663 | 35 |



Fig.6.7. Common Duct from Paddy Separators (2nd floor) (Port Hole 10)

Fig. 6.8. ID Fan Inlet (Port Hole 8) on 4th Floor



Fig.6.9. Outlet from Single Huller (Port Hole 4) on 3rd floor



Fig.6.10. Cyclone Inlet (Port Hole 7) on 4th floor

Photographs showing various Sampling Locations

b) Fugitive Emission Assessment

To assess the quantum of Fugitive Emissions generated due to inadequate extraction at some locations, measurement of Total Suspended Particulate Matter and PM 10 was done using samplers.

| MONITORING LOCATIONS | | PARAMETERS | | |
|----------------------|--|----------------------------------|------------------------------|---------|
| | | TSPM($\mu\text{g}/\text{m}^3$) | PM 10 | |
| | | | ($\mu\text{g}/\text{m}^3$) | % fines |
| Location 1 | Ground Floor of Milling Section | 1570 | 596 | 38 |
| Location 2 | 4 th Floor of Milling Section | 4365 | 1261 | 29 |



Fig.6.12. 4th Floor of Milling Section



Fig.6.11. Ground Floor (Milling Section)

Observation: Apart from extraction systems provided for various sections, the fugitive emission leads to high values of TSPM and PM 10, which could be due to inadequate extraction at some locations.

3. Monitoring at Boiler House

Fugitive emission at Boiler House

| MONITORING LOCATIONS | | PARAMETERS | | |
|----------------------|---|----------------------------------|------------------------------|---------|
| | | TSPM($\mu\text{g}/\text{m}^3$) | PM 10 | |
| | | | ($\mu\text{g}/\text{m}^3$) | % fines |
| Location 1 | Near Boiler House (at ash discharge point) | 661 | 433 | 66 |

4. Ambient Monitoring at Unit 1

| MONITORING LOCATIONS | | PARAMETERS | | | | |
|----------------------|--|--------------------------------------|------------------------------|---------|-----------------|-----------------|
| | | TSPM ($\mu\text{g}/\text{m}^3$) | PM 10 | | SO _x | NO _x |
| | | | ($\mu\text{g}/\text{m}^3$) | % fines | | |
| Location 1 | Near Factory Gate (North East Corner) | 293 | 117 | 40 | 24 | 34 |
| Location 2 | Near Civil Block (South East Corner) | 496 | 178 | 36 | - | - |
| Location 3 | Near ETP Plant (North West Corner) | 446 | 145 | 33 | - | - |
| Location 4 | Near Plant Colony (South West Corner) | 273 | 171 | 63 | 11 | 23 |



Fig.6.13 Near Factory Gate



Fig.6.14 Near ETP Plant



Fig. 6.15 Near Plant Colony

Observation: The TSPM concentration in Ambient Air is found to be higher at some locations.

Unit 2 (Code 2):**1. Ambient Air Monitoring:**

Ambient Air Monitoring was conducted at and beyond the unit boundary at 3 locations.

- a) Location 1 (Downwind side) : South West Corner of the plant
- b) Location 2 (Upwind side) : North West Corner of the plant
(100 m away from the plant)
- c) Location 3 (Upwind side) : South Side of plant

| MONITORING LOCATIONS | | PARAMETERS | | |
|-------------------------------|--------------------------------|--------------------------------------|------------------------------|---------|
| | | TSPM ($\mu\text{g}/\text{m}^3$) | PM 10 | |
| | | | ($\mu\text{g}/\text{m}^3$) | % fines |
| Location 1 (Downwind side) | South West Corner of the plant | 974 | 306 | 32 |
| Location 2 (Upwind side) | North West Corner of the plant | 404 | 129 | 32 |
| Location 3 (Upwind side) | South Side of plant | 270 | 161 | 60 |



Fig.6.16. Downwind Side



Fig.6.17. Upwind Side

Observation: The Ambient Air Concentration was found to be higher at 2 locations.

2. Monitoring at Milling Section:

a) Stack monitoring:

Location 1 : b/w ID Fan and Cyclone

Location 2 : After Cyclone in Stack

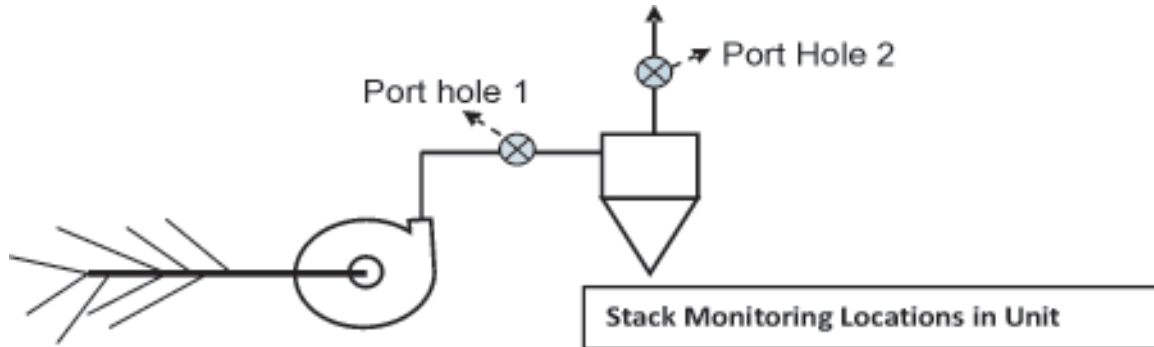

| Port Hole Location | Port Hole 1 | Port Hole 2 |
|--|------------------------|------------------------|
| | b/w ID Fan and Cyclone | After Cyclone in Stack |
| Parameters | | |
| Diameter (m) | 0.25 | 0.25 |
| Cross Sec. Area (m ²) | 0.05 | 0.05 |
| Stack Temp. (°C) | 31 | 31 |
| velocity(m/sec) | 15.1 | 16.5 |
| Flow Rate (Nm ³ /hr) | 2642 | 2829 |
| Static Pressure (mmwc) | +39 | +3.3 |
| Particulate Matter (mg/Nm ³) | 92.3 | 45.8 |

b) Fugitive Emission Assessment

| MONITORING LOCATIONS | | PARAMETERS | | |
|----------------------|----------------------------------|------------------------------|----------------------|---------|
| | | TSPM (µg/m ³) | PM 10 | |
| | | | (µg/m ³) | % fines |
| Location 1 | Near the door of Milling Section | 2524 | 1882 | 75 |

Observations: There were substantial fugitive emissions observed which is indicated by the high TSPM measurements. This could be because the dust extraction from some locations was not adequate and therefore only partial dust is sucked by the system, hence, lower dust concentrations in the extracted air.

Unit 3 (Code 3):

1. Monitoring at Milling Section:

a. Stack Monitoring:

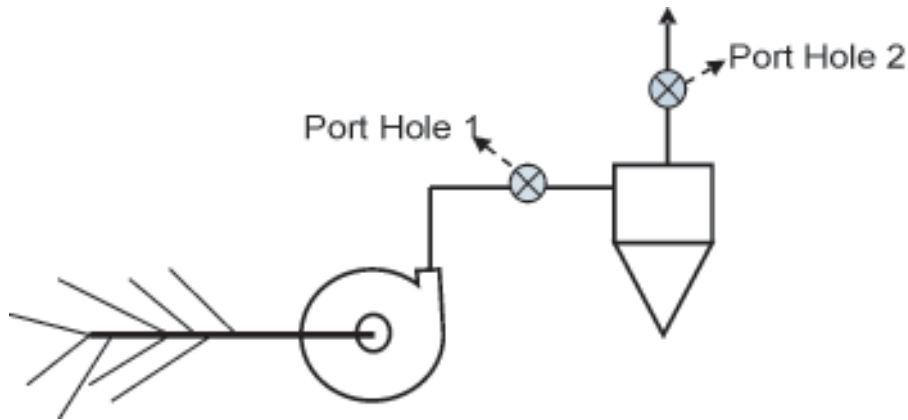

| Port Hole Location | Port Hole 1 | Port Hole 2 |
|--|------------------------|------------------------|
| | b/w ID Fan and Cyclone | After Cyclone in Stack |
| Parameters | | |
| Diameter (m) | 0.25 | 0.25 |
| Cross Sec. Area (m ²) | 0.05 | 0.05 |
| Stack Temp. (æ% C) | 31 | 31 |
| velocity(m/sec) | 13.5 | 11.4 |
| Flow Rate (Nm ³ /hr) | 2330 | 1964 |
| Static Pressure (mmwc) | +38 | +1.8 |
| Particulate Matter (mg/Nm ³) | 96.4 | 43.8+3.3 |
| Particulate Matter (mg/Nm ³) | 92.3 | 45.8 |

b) Fugitive Emission Assessment

| MONITORING LOCATIONS | | PARAMETERS | | |
|----------------------|----------------------------------|------------------------------|----------------------|---------|
| | | TSPM (µg/m ³) | PM 10 | |
| | | | (µg/m ³) | % fines |
| Location 1 | Near the door of Milling Section | 4482 | 3406 | 76 |

Observations: There were substantial fugitive emissions observed which is indicated by the high TSPM measurements. This could be because the dust extraction from some locations was not adequate and therefore only partial dust is sucked by the system, hence, lower dust concentrations in the extracted air.

Unit 4 (Code 4):

1. Monitoring in Pre-cleaning Section:

a) Stack Monitoring

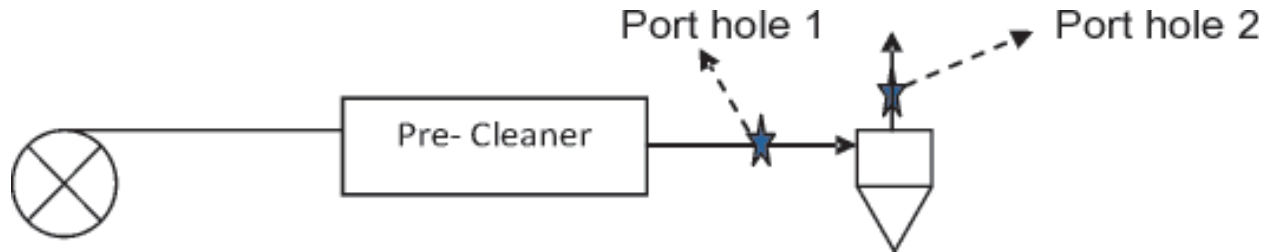

| Parameters | Pre-Cleaning Section | |
|--|----------------------------|-----------------------------|
| | Cyclone Inlet(Port hole 1) | Cyclone Outlet(Port hole 2) |
| Diameter (m) | 0.3 | 0.3 |
| Cross Sec. Area (m ²) | 0.07 | 0.07 |
| Stack Temp. (æ°C) | 31 | 31 |
| velocity(m/sec) | 10.7 | 11.1 |
| Flow Rate (Nm ³ /hr) | 2677 | 2758 |
| Static Pressure (mmwc) | +96 | +2.5 |
| Particulate Matter (mg/Nm ³) | 45.6 | 41.7 |

b) Fugitive Emission Assessment

| MONITORING LOCATIONS | | PARAMETERS | | |
|----------------------|------------------------------------|------------------------------|----------------------|---------|
| | | TSPM (µg/m ³) | PM 10 | |
| | | | (µg/m ³) | % fines |
| Location 1 | Pre-cleaning room of Raw Rice Mill | 906 | 461 | 51 |

2. Monitoring in Milling Section

a) Fugitive Emission Assessment

| MONITORING LOCATIONS | | PARAMETERS | | |
|----------------------|---|--------------------------------------|------------------------------|---------|
| | | TSPM ($\mu\text{g}/\text{m}^3$) | PM 10 | |
| | | | ($\mu\text{g}/\text{m}^3$) | % fines |
| Location 2 | Milling Section extraction cyclones outlet area | 3293 | 1966 | 60 |

2. Monitoring at Polishing Section:

| Parameters | Measured values at Polishing Section Stack |
|--|--|
| Diameter (m) | 0.3 |
| Cross Sec. Area (m^2) | 0.07 |
| Stack Temp. ($^{\circ}\text{C}$) | 31 |
| velocity(m/sec) | 10.8 |
| Flow Rate (Nm^3/hr) | 2549 |
| Static Pressure (mmwc) | 54 |
| Particulate Matter (mg/Nm^3) | 32.7 |

Observations: There were substantial fugitive emissions observed which is indicated by the high TSPM measurements. This could be because the dust extraction from some locations was not adequate and therefore only partial dust is sucked by the system, hence, lower dust concentrations in the extracted air.

Unit 5 (Code 5):

1. Monitoring at Pre-cleaning Section:

a) Stack Monitoring:

- At the outlet of Pre-cleaner.

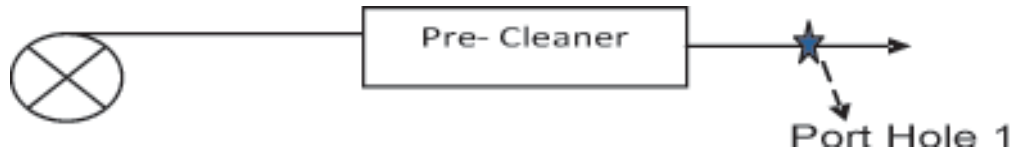

| Parameters | Measured values at Outlet of Pre-Cleaner |
|--|--|
| Diameter (m) | 0.3 |
| Cross Sec. Area (m ²) | 0.07 |
| Stack Temp. (°C) | 31 |
| velocity(m/sec) | 6 |
| Flow Rate (Nm ³ /hr) | 1488 |
| Static Pressure (mmwc) | +12 |
| Particulate Matter (mg/Nm ³) | 86.9 |

2. Monitoring at Milling Section

| MONITORING LOCATIONS | | PARAMETERS | | |
|----------------------|----------------------------------|------------------------------|----------------------|---------|
| | | TSPM (µg/m ³) | PM 10 | |
| | | | (µg/m ³) | % fines |
| Location 1 | Near the door of Milling Section | 926 | 335 | 32 |

Observations: There were substantial fugitive emissions observed which is indicated by the high TSPM measurements. This could be because the dust extraction from some locations was not adequate and therefore only partial dust is sucked by the system, hence, lower dust concentrations in the extracted air.

Unit 6 (Code 8):

1. Monitoring at Pre-cleaning Section:

a) Stack Monitoring

| MONITORING LOCATION | PARAMETERS | | | | | |
|---------------------|--------------|------------------|----------------|------------------------|--------------------------|--|
| | Diameter (m) | Stack Temp. (°C) | velocity (m/s) | Static Pressure (mmwc) | Flow Nm ³ /hr | Particulate Matter (mg/Nm ³) |
| Pre cleaning Outlet | 0.33 | 34 | 9.3 | +14 | 2765 | 32.6 |

b) Fugitive Emission Assessment

| MONITORING LOCATIONS | PARAMETERS | | |
|---------------------------|--------------------------|----------------------|---------|
| | TSPM(µg/m ³) | PM 10 | |
| | | (µg/m ³) | % fines |
| Near Pre-Cleaning Section | 1753 | 561 | 32 |

2. Monitoring at Milling Section:

a) Stack Monitoring

| MONITORING LOCATION | PARAMETERS | | | | | |
|-----------------------|--------------|------------------|----------------|------------------------|--------------------------|--|
| | Diameter (m) | Stack Temp. (°C) | velocity (m/s) | Static Pressure (mmwc) | Flow Nm ³ /hr | Particulate Matter (mg/Nm ³) |
| Milling Section Stack | 0.33 | 34 | 19.9 | 4.8 | 5935 | 52.3 |

Observations: There were substantial fugitive emissions observed which is indicated by the high TSPM measurements. This could be because the dust extraction from some locations was not adequate and therefore only partial dust is sucked by the system, hence, lower dust concentrations in the extracted air.

Unit 7 (Code 11):

1. Monitoring at pre cleaning section:

a) Stack Monitoring

| MONITORING LOCATION | | PARAMETERS | | | | | |
|---------------------|---------------------|--------------|------------------|----------------|------------------------|--------------------------|--|
| | | Diameter (m) | Stack Temp. (°C) | velocity (m/s) | Static Pressure (mmwc) | Flow Nm ³ /hr | Particulate Matter (mg/Nm ³) |
| Location 1 | Pre cleaning outlet | 0.15 | 32 | 12.6 | +19 | 777 | 39.1 |

b) Fugitive Emissions Assessment

| MONITORING LOCATIONS | PARAMETERS | | |
|---------------------------|--------------------------|----------------------|---------|
| | TSPM(µg/m ³) | PM 10 | |
| | | (µg/m ³) | % fines |
| Near Pre-Cleaning Section | 16110 | 9115 | 56 |

Observations: There were substantial fugitive emissions observed which is indicated by the high TSPM measurements. This could be because the dust extraction from some locations was not adequate and therefore only partial dust is sucked by the system, hence, lower dust concentrations in the extracted air.

6.1.4 Monitored SO₂ and NO_x Values in Various Rice Mills

| Unit Code | Location | SO ₂ Concentration | | Avg. SO ₂ Conc. |
|-----------|-------------------|-------------------------------|----------|----------------------------|
| | | Sample 1 | Sample 2 | |
| 1. | Near Factory Gate | 23.8 | 24.2 | 24 |
| 1. | Near Plant Colony | 10.9 | 11.1 | 11 |
| 8. | Near Main Gate | 7.5 | 7.8 | 7.6 |
| 11. | Near Main Gate | 9.5 | 10.1 | 9.8 |

| Unit Code | Location | NO _x Concentration | | Avg. NO _x Conc. |
|-----------|-------------------|-------------------------------|----------|----------------------------|
| | | Sample 1 | Sample 2 | |
| 1. | Near Factory Gate | 33.8 | 34.1 | 34 |
| 1. | Near Plant Colony | 22 | 24.5 | 23 |
| 8. | Near Main Gate | 13 | 13.7 | 13.4 |
| 11. | Near Main Gate | 16.3 | 16.5 | 16.4 |

FUGITIVE EMISSIONS IN RICE MILLS

7.1 Escape of unextracted fine dust from Paddy Unloading Area and its Conveyance System:

In the unloading section, the paddy bags are cut open and paddy emptied out in the pit, from where it is conveyed to bucket elevators for conveying to the pre-cleaning section. Due to free fall, substantial fine dust is generated during unloading of paddy and its conveyance. This fine dust escapes in the mill environment due to inadequate extraction arrangement from the Unloading pit, the Bucket Elevator, the Discharge Points, etc.

7.2 Fugitive Emissions of Unextracted and Uncaptured fines from Paddy Cleaning Section:

The objective of the pre-cleaning section is to remove the fine dust and dirt from the unloaded paddy before it goes to parboiling/milling section. During pre-cleaning activity the separated fine dust from paddy escapes in and around the pre-cleaning section due to following main reasons:

- Lack of extraction systems in the pre-cleaning section mainly in small rice mills (instead, only blowing of Dirt/ Dust is done with the help of a Blower).
- Inefficient extraction systems in the pre-cleaning section, mainly in small rice mills where number of flexible pipes are taken from main duct. The duct connections are not appropriate; hence sucking capacity from various equipments varies and does not match the requirement.
- Poor design, operation and maintenance to existing extraction cum control systems. Mills employing cyclone followed by bag-filter are observed to be having substantial dust and fugitive emissions, may be due to choking of filter bags, inappropriate cleaning of bags, inappropriate extraction locations, etc.
- Limitation of employed control system.
The fine dust $d > 10$ micron can only be effectively controlled using bag-filters and most of the small and medium mills have adopted cyclone as APCD.

7.3 Unextracted and Uncaptured Fines from Milling Section:

In the milling section during husk removal substantial quantities of fine particles of rice husk are generated due to breaking of husk in hullers and husk separation in de-huskers. During milling of paddy fine rice husk escapes in the milling section due to following main reasons:

- Lack of extraction systems in the milling section mainly in small rice mills.
- Inefficient extraction systems in the milling section, mainly in small rice mills where number of flexible extraction ducts from various operations enter a common header duct.
- Poor design, operation and maintenance to existing extraction cum control systems. Mills employing cyclones with blowers/ID fans are observed to be having substantial dust and fugitive emissions.

- Limitation of employed fugitive emission control system. The fine dust $d > 10$ micron can only be effectively controlled using bag-filters and most of the small and medium mills have adopted cyclones in the milling section which are not suitable for controlling fine dust emission.

7.4 Unextracted fine dust particles in Husk stored in Open Areas:

In rice mills the rice husk is handled using different systems and stored in husk storage yard in open/partially covered or in closed storage. The fugitive dust emission during rice husk handling and storage happens due to following main reasons:

- Non-removal of fines from the husk before storage. In many small mills husk is blown to storage area without extracting fines from it.
- Inefficient removal of fines from the husk before storage. Many mills have blower with cyclone which remove only coarser dust particles.
- Common open storage of rice husk and rice bran fines.
- Inefficient extraction systems in the milling section. Poor design, operation and maintenance of existing extraction cum control systems.
- Limitation of employed fugitive emission control system. The fine dust $d > 10$ micron can only be effectively controlled using bag-filters and most of the small and medium mills have adopted cyclones for husk separation which are not suitable for controlling fine dust emission.

7.5 Fine dust Emissions from the Ash Disposal:

In rice mills ash is generated in the boiler section. This ash escapes from the boiler section due to following main reasons:

- Open temporary storage of boiler ash in the mills- fines get airborne due to wind currents.
- Disposal of boiler ash in the unprotected landfill site- dust gets re-entrained due to wind.

ANALYSIS OF EXISTING DUST CONTROL ARRANGEMENTS & POSSIBLE MODIFICATIONS FOR IMPROVEMENT

8.1 Dust extraction system for paddy cleaning section –

Such systems are typically employed in most rice mills. The most predominant problem identified is:

- That there are substantial fugitive emissions from various locations like belt conveyor, bucket elevator discharge locations, from the vent of storage silo and the cleaning screen area.

It is generally perceived that the fine dust adhering to paddy keeps getting loosened/separated, right from bag unloading point upto the cleaning screen and it gets accumulated and can be extracted at the final point i.e. screen.

But, because, the system of conveying & storage of paddy is not air-tight hence the fine dust, as and when generated, escapes to atmosphere through the openings/leakages in the system. Even if all the leakages/openings are closed or sealed, the fine dust would escape through the vent of the storage vessel, through openings for discharging material.

It is, therefore, necessary to extract / suck the fine dust particles from various locations simultaneously like transfer points, point of free fall Paddy, vents of storage bins/ silos, vibratory/rotary screens etc.

Minimum air volume to be extracted

The most authentic design handbook, namely “Industrial Ventilation” (a manual of recommended practices, 23rd edition, 1998, by American Conference of Governmental Industrial hygienists, USA), gives the “basic minimum” extraction volumes to be extracted from belt conveyors, bucket elevators and screens, which shall be followed while designing an appropriate dust extraction system.

In the large unit studied (Unit-1), employing above type of systems, the measured parameters are as below:

(i) System for Paddy-cleaning section at Unit 1:

System comprises of a single point dust extraction from vibratory screen, a cyclone followed by bag filter, ID fan and stack

Measurements were conducted at cyclone inlet, between cyclone & bag filter, between bag filter & ID fan and at the outlet of ID fan in the stack. The measurement shows the following problems in the dust extraction system.

- The actual flow extracted by the ID fan was 22123 Nm³/hr, out of which the useful volume actually extracted from the vibratory screen was only 14495 Nm³/hr (which is about 65% only). The balance 35% flow are leakages, 2993 Nm³/hr from cyclone bottom (14%) and 4635 Nm³/hr from bagfilter casing leakages (21%). These leakages of about 35% in the system adversely affect the performance of the dust extraction system.
- The pressure drop across the bagfilter was measured to be 222 mmWC which is quite high and could be due to improper cleaning of the filter bags resulting in formation of thick dust layer on the filter cloth.
- Substantial fugitive emission were observed from the vibratory screen through front side opening as well as leakages from the screen sides which indicate inadequate extraction of dust from the cleaning screen.
- The fugitive emission assessment done using respirable type high volume sampler (RDS) placed at ground floor (at about 5 meter distance from the vibratory screen) indicated TSPM in the range of 3699 and PM 10 in the range of 3677 ug/m³. This high value of emissions indicate substantial fugitive emissions from the cleaning section.
- The respirable particulate matter (PM 10, less than 10 micron size) is about 99% in the total suspended particulate matter (TSPM), which indicates that almost all the fugitive emissions from the cleaning sections are very fine in size which can only be captured by bag filters.

Even though large volume of extraction is provided (about 15000 Nm³/h) which may be even more than that required (as per the technical design handbook specifications), but still not able to extract the dust emissions adequately resulting in substantial fugitive emissions, because all the sucking is provided only at 1 point i.e. the vibratory screen, which is a wrong design instead of sucking dust from various required locations like belt conveyor transfer points, bucket elevators, storage silos etc.,

In nutshell, even if the industry has installed more than adequate size of dust extraction cum bag filter system and have made substantial investment on the equipment, associated with high operating costs of running the ID fan, still substantial fugitive emission occur, thereby defeating the very purpose of installing dust extraction cum control system.

This is primarily because of in-appropriate design of dust extraction network and improper maintenance of the cyclone and bag filter leading to leakages in the system and high pressure drop in bag filter.

Therefore, it is necessary to provide technical guidance to rice mills for the required volume of air to be extracted from various locations.

(ii) System for cleaning section of Unit 2 -

Substantial fugitive emissions were observed from the cleaning section which indicate inadequate extraction of dust from the cleaning screen.

The fugitive emission assessment done using respirable type high volume sampler (RDS) placed at ground floor (at about 5 meter distance from the screen) indicated TSPM in the range of 2524 and PM 10 in the range of 1882 ug/m³. The high emission values indicate substantial fugitive emissions from the cleaning section.

The respirable particulate matter (PM 10), less than 10 micron size, is about 75% in the total suspended particulate matter (TSPM), which indicates that majority of the

fugitive emissions from the cleaning section are very fine in size and can only be captured by bag filter.

The Unit has dust extraction cum cyclone type system. From the main pipe at the ID fan inlet, there are many flexible pipes branching out to various locations for sucking dust. Uniform distribution of flow is not maintained and the branching of the ducts from the main header unscientifically done, a design fault and hence cannot ensure optimal dust extraction from various locations.

Though the industry has installed a dust extraction system sucking about 2800 Nm³/h volume, due to improper design of the branch ducts and its connections with the main header, the system cannot ensure appropriate extraction of fine dust from required locations and hence appropriate technical guidance need to be provided to the rice mill to help them design and adopt proper dust extraction system.

(iii) System for cleaning section of Unit 3 -

Substantial fugitive emissions were observed from the cleaning section which indicate inadequate extraction of dust from the cleaning screen.

The fugitive emission assessment done using respirable type high volume sampler (RDS) placed at ground floor (at about 5 meter distance from the screen) indicated TSPM in the range of 4482 and PM 10 in the range of 3406 µg/m³. The high emission value indicate substantial fugitive emissions from the cleaning section.

The respirable particulate matter (PM 10), less than 10 micron size, is about 76% in the total suspended particulate matter (TSPM), which indicates that mostly of the fugitive emissions from the cleaning section are very fine in size which can only be captured by bag filter.

The Unit has dust extraction cum cyclone type system. From the main pipe at the ID fan inlet, many flexible pipes branches are taken out to various locations for sucking dust. Uniform distribution of flow is not maintained rather branching of the ducts from the main header unscientifically done, a design fault and hence cannot ensure appropriate dust extraction from different locations.

Though the industry has installed a dust extraction system sucking about 2330 Nm³/h volume, due to improper design of the branch ducts and its connections with the main header, the system cannot ensure appropriate extraction of fine dust from required locations and hence appropriate technical guidance need to be provided to the rice mill to help them design and adopt proper dust extraction system.

8.2 Dust extraction system for Milling section –

(i) System for Milling Section at Unit 1:

Different extraction systems are installed to extract dust from various sections :

- Dust extraction system for paddy final cleaner
- Dust extraction system for d-stoners

- Dust extraction system for paddy weigher machine
- Dust extraction system for Paddy separator / huller
- Dust extraction system for aspirators

All the above extraction systems have dust extraction pipes for one or more points with a cyclone and an ID fan followed by a pipe exhausting the air outside the milling shed. There are no provisions of portholes in the system and therefore stack monitoring could not be done. However, the volumes extracted were measured which are as below :

- Dust extraction system for paddy final cleaner (18712 Nm³/h)
- Dust extraction system for paddy weigher machine (4663 Nm³/h)
- Dust extraction system for Paddy separator / huller (11434 Nm³/h)
- Dust extraction system for aspirators (6361 Nm³/h)

The fugitive emission assessment done using respirable type high volume sampler (RDS) placed at ground floor indicated TSPM in the range of 1570 and PM 10 in the range of 596 µg/m³ and 4365 and PM 10 in the range of 1261 µg/m³ at fourth floor level. The high emission values indicate substantial fugitive emissions in the milling section.

(ii) System for Milling Section at Unit 2:

The extraction system has dust extraction pipes for one or more points with a cyclone and an ID fan followed by a pipe exhausting the air outside the milling shed. There are no provisions of portholes in the system and therefore stack monitoring could not be done.

The fugitive emission assessment done using respirable type high volume sampler (RDS) placed at ground floor indicated TSPM in the range of 2524 and PM 10 in the range of 1882 µg/m³. The high emission values indicate substantial fugitive emissions in the milling section. These fine particles get carried away with the husk and can get airborne due to wind carry over.

(iii) System for Milling Section at Unit 3:

The extraction system has dust extraction pipes for one or more points with a cyclone and an ID fan followed by a pipe exhausting the air outside the milling shed. There are no provisions of portholes in the system and therefore stack monitoring could not be done.

The fugitive emission assessment done using respirable type high volume sampler (RDS) placed at ground floor indicated TSPM in the range of 4482 and PM 10 in the range of 3406 µg/m³. The high emission values indicate substantial fugitive emissions in the milling section. These fine particles get carried away with the husk and can get airborne due to wind carry over. It is, therefore, important to install appropriate dust extraction cum bag filter type dust control system.

(iv) System for Milling Section at Unit 4:

The extraction system has dust extraction pipes for one or more points with a cyclone and an ID fan followed by a pipe exhausting the air outside the milling shed. There are no provisions of portholes in the system and therefore stack monitoring could not be done.

The dust extracted from the milling section is passed through cyclones kept inside a room, without any outlet stack but only a short pipe for outlet above the cyclone which ends within the shop floor roof and all the air exhausted from cyclone along with fine dust is exhausted from the room door. The fugitive emission assessment done using respirable type high volume sampler (RDS) placed near the door indicated TSPM in the range of 3293 and PM 10 in the range of 1966 $\mu\text{g}/\text{m}^3$. The high emission values indicate substantial escaping of fine dust as fugitive emissions from the milling section. These fine particles can get airborne due to wind carry over. It is, therefore, important to install appropriate dust extraction cum bag filter type dust control system.

8.3 Dust Extraction system for small capacity (< 4 tonne/hr) rice mills:

The Unit has dust extraction cum cyclone type system. From the main pipe at the ID fan inlet, many flexible pipes branch out to various locations for sucking dust. There is no uniform distribution of flow and the branching of the ducts unscientifically done, which is a design fault and hence cannot ensure appropriate dust extraction from various locations.

Though the industry has installed a dust extraction arrangement sucking about 2800 Nm^3/h volume, due to improper design of the branch ducts and its connections with the main header, the system cannot ensure appropriate extraction of fine dust from required locations and hence appropriate technical guidance needs to be provided to the rice mill to help them design and adopt proper dust extraction system.

Proper duct branching at proper angle from the main pipe (30 deg) should be provided for optimal extraction of dust. A comparison of existing arrangement Vs required arrangement is shown below.



Existing Dust Extraction cum Control System

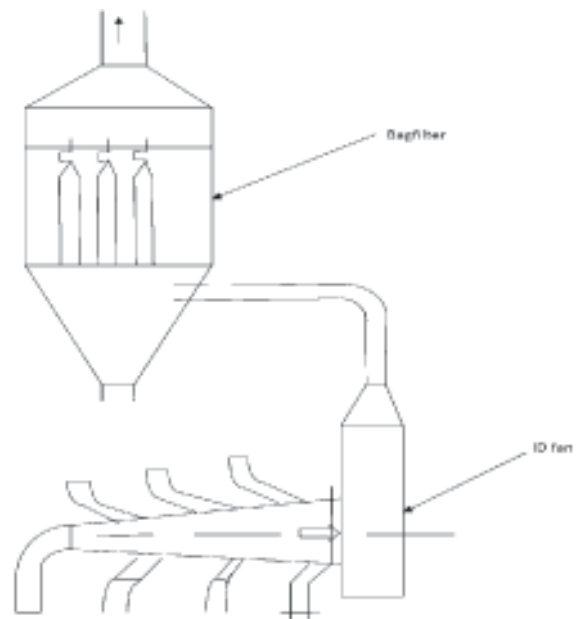

Proper Branch Ducts connected at 30p angle, equally spaced, properly sized Preferred/ Required dust Extraction cum Control System

Fig 8.1: Comparison of Existing Vs Required Dust Extraction cum Control System for Rice Mills (For paddy cleaning section)

8.4 Rice Husk Handling & Storage Practices:

(i) Characteristics of Rice Husk*

- Rice husk is difficult to ignite and it does not burn easily with open flame unless air is blown through the husk. One concern in rice husk firing is the behavior of the ash, i.e., its slagging and fouling tendency caused by a low melting point of the rice husk ash.
- When burned the ash content is about 25%, a lot higher than wood (0.2-2%). This means when used for steam generation large amounts of ash need to be handled.
- Rice husk has a average calorific value of 3410 kcal/kg and therefore is a good, renewable energy source.
- It is highly resistant to moisture penetration and fungal decomposition. Husk therefore makes a good insulation material.
- Because of the high silica content rice husk is very abrasive and wears conveying elements quickly.
- Rice husk has low bulk density of only 70-110 kg/m³, 145 kg/m³ when vibrated or 180kg/m³ in form of bricks or pellets. It thus requires large volumes for storage and transport, which makes transport over long distances un-economical
- Handling of rice husk is difficult because it is bulky and dusty. It has angle of repose of about 40-45° which means that it's flow ability, e.g. in feed hoppers is very poor.
- Rice husk has a high silica (SiO₂) content which means that it decomposes slowly when brought back to the field. It also makes it a poor fodder.

*Source: International Rice Research Institute, Philippines (www.knowledgebank.irri.org)

- (ii) **Quantity of Husk & Ash generation from Paddy:** Husk contains about 75 % organic volatile matter and the balance 25% of the weight of this husk is converted into ash during the firing process, known as Rice Husk Ash (RHA). This RHA in turn contains around 80% - 90% silica. For every 1000 kgs of paddy milled, about 220 kgs (22 %) of husk is produced, and when this husk is burnt in the boilers, about 55 kgs (25 %) of RHA is generated.

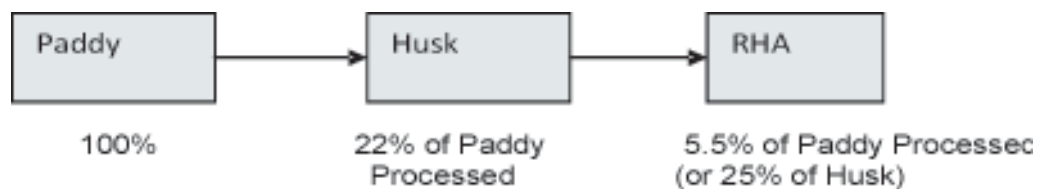

Based on the above, typical ash quantities generated per day by various sites of Rice Mills is shown below:

Table 8.4.1: Typical Ash Balance for various size Rice Mills

| Paddy Milling Capacity (tonne/hr) | Amount of Ash generated per hour (kg/hr) |
|-----------------------------------|--|
| 1 | 55 |
| 2 | 110 |
| 5 | 275 |
| 25 | 1375 |

(iii) Typical Composition of Rice Husk Boiler Ash

Typical composition of Boiler Ash from Rice Husk fired Boiler is as below:

Table 8.4.2: Composition of Rice Husk Ash on Dry Basis*

| Constituent | Mass Fraction % |
|----------------------------|-----------------|
| Silica (SiO ₂) | 80-90 |
| Alumina | 1-2.5 |
| Ferric oxide | 0.5 |
| Calcium oxide | 1-2 |
| Magnesium oxide | 0.5-2.0 |
| Sodium oxide | 0.2-0.5 |
| Potash | 0.2 |
| Loss on ignition | 10-20 |

*Source: D.N. Subbukrishna, K.C. Suresh, P.J.Paul, S. Dasappa and N.K.S. Rajan – “Precipitated Silica from Rice Husk Ash by IPSIT Process” (Combustion, Gasification & Propulsion Laboratory, IISc, Bengaluru). 15th European Biomass Conference and Exhibition, May 2007.

Unburnt Carbon in the Ash may vary from unit to unit and depends on type of combustion in respective boilers. Following Table shows Typical Unburnt Carbon % in Boiler Ash, from 3 rice mills studied.

Table 8.4.3: % Carbon in Rice Husk Ash Samples from various Rice Mills

| S.No. | Unit Code No. | Milling Capacity | Type of Combustion | Appearance of Ash | % of Unburnt Carbon |
|-------|---------------|------------------|-----------------------------|-------------------|---------------------|
| 1. | 1 | 55 tonne/hr | Travelling & Pulsating rate | Grey | 6.98 |
| 2. | 4 | 12 tonne/hr | Extended Combustion | Blackish | 8.83 |
| 3. | 5 | 2 tonne/hr | Fluidized Bed | White | 0.24 |

(iv) Minimum area requirement for storage of rice husk

The rice husk requires large storage area as its bulk density is low (average about 90 Kg/m³). A natural heap of husk, maximum height of 4 meter & angle of repose 45° will occupy 8 meter diameter; area (50 m² floor area) & can hold 6 tonne of husk (8.3 m² Area/Tonne of husk).

Assuming that a minimum of 10 hour operations/day of a 1 tonne/hr capacity Rice Mill, will generate about 220 kg/hr x 10 hrs = 2.2 tonne/day of husk.

Table 8.4.4: Typical storage Volume required for various capacity mills

| Paddy Processing Capacity (tonne/hr) | Quantity of husk generated | | Storage Volume required for storing 1 week husk quantity (m ³) |
|--------------------------------------|----------------------------|------------|--|
| | Kg/hr | tonne/Week | |
| 1 | 220 | 15.4 | 171 |
| 2 | 440 | 30.8 | 343 |
| 5 | 1100 | 77 | 856 |
| 10 | 2200 | 154 | 1712 |
| 25 | 5500 | 385 | 4278 |

8.5 Blowing of husk in storage area

Presently, many rice mills blow the husk (from the de-husker) by a blower in the open area outside the factory shed wall. The husk falls to ground by gravity & forms heap. The size of heap keeps growing as more & more husk is blown. This openly stores husk leads to generation of dust due to wind blowing.

To avoid this environmental air pollution problem, the blowing of husk should be done into a closed room. The room should be provided with an access door (to be kept closed during blowing) and a vent in the roof to release the air. The vent pipe should be attached to a filter-bag arrangement to arrest the fine particles. The size of the room would depend on the quantity of husk blown per hour & minimum storage quantity required.

8.6 Technical specification of volume to be extracted from various material handling equipment:

| Table 8.6: Technical Specifications for Dust Extraction* | | |
|--|--|---------------------------|
| Mode of material handling/ equipment | Volume to be extracted | Referred page of handbook |
| Belt conveyor(<1m/sec) (>1m/sec) | 1950 m ³ /metre belt width 2790 m ³ /metre belt width | VS-50-01 |
| Bucket elevator | 1830 m ³ /m ² Cross section Area | VS-50-01 |
| Screens(vibratory/ rotary) | 915 m ³ /m ² Cross section Area | VS-99-01 |
| Storage bins | 3660 m ³ /m ²) of all open area | VS-50-10 |

*Source: "Handbook on Industrial Ventilation" (a manual of recommended practices, 23rd edition, 1998, by American Conference of Governmental Industrial hygienists, USA)

As per the above specifications, a sample calculation of volume to be extracted from various locations from paddy unloading upto the cleaning screen section is shown in the diagram below (figure 8.1) and subsequent calculated values in the table below.

A sketch comparing the existing extraction system and a technically appropriate extraction system is shown below, to provide guidance to the rice mills.

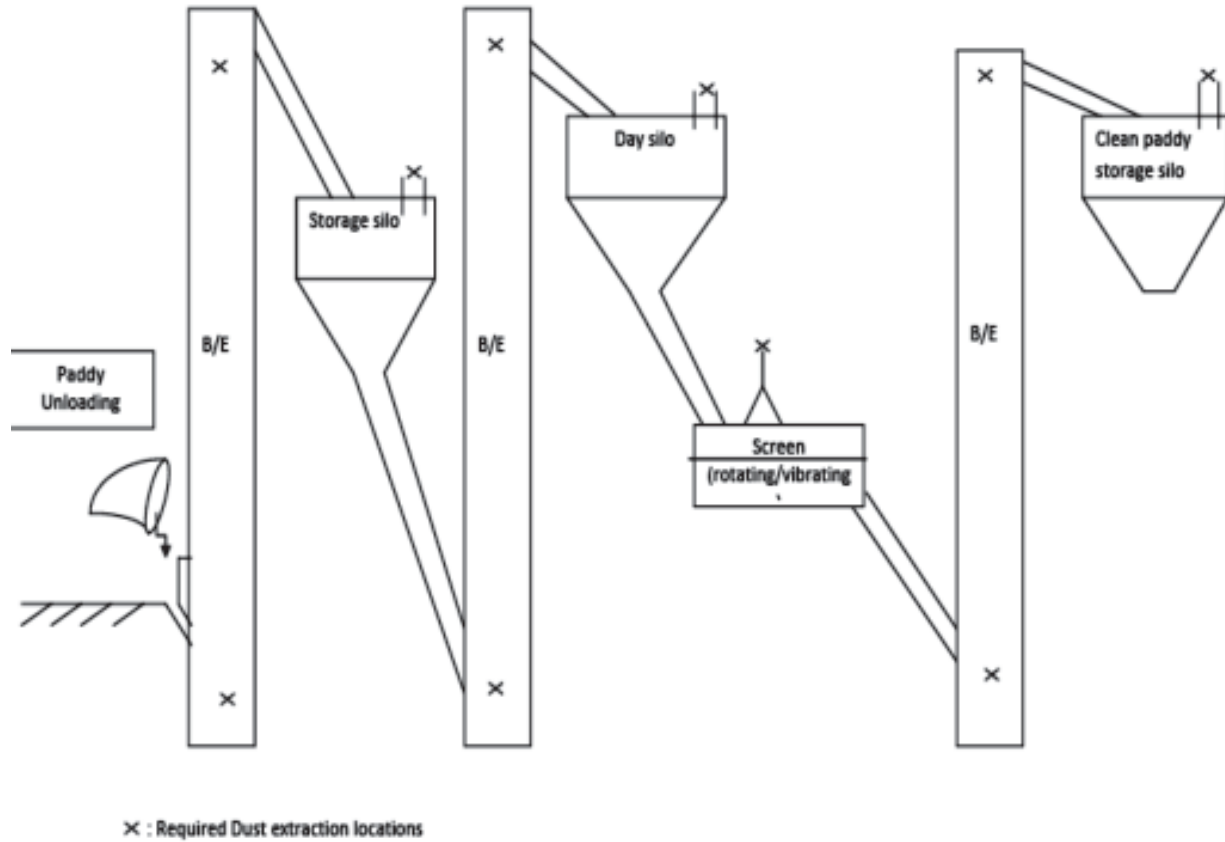

Typical Set of Paddy unloading to Cleaning Section showing "Required Dust Extraction locations"

Figure 8.2

8.7 Typical volume to be extracted from various locations: Typical Volume to be extracted from various locations for a large size Rice mill (unit 1, 30 tonne/hr paddy processing) (from paddy unloading to cleaning screen)

Table: 8.7: Typical Volume to be Extracted from Various Locations

| Location No | Items | Width (m) | Breadth (m) | From | To | Processing area | Specific volume to be extracted | Total volume to be extracted | Actual Volume extracted in unit 1 |
|--------------|-------------------|---|-------------|--------------|-------------------|-----------------|---|------------------------------|-----------------------------------|
| 1 | Belt conveyor 1 | 0.45 | - | Unloading | Bucket elevator 1 | 1.5 | 1983 m ³ /m | 892 | - |
| 2 | Bucket Elevator 1 | 0.75 | 0.45 | BC 1 | Next | 3.75(top) | 1890 m ³ /m ² | 640 | - |
| 3 | Bucket Elevator 1 | 0.75 | 0.45 | BC 1 | BE 2 | 3.75 (bottom) | 1890 m ³ /m ² | 640 | - |
| 4 | Bucket Elevator 2 | 0.75 | 0.45 | BE 1 | Storage silo | 3.75 (top) | 1890 m ³ /m ² | 640 | - |
| 5 | Bucket Elevator 2 | 0.75 | 0.45 | BE 1 | Storage silo | 3.75 (bottom) | 1890 m ³ /m ² | 640 | - |
| 6 | Silo(opening) | 0.45 | 0.45 | Front end | Rear end | 2.25 | 3777 m ³ /m ² opening | 1105 | - |
| 7 | Bucket Elevator 3 | 0.75 | 0.45 | Storage silo | Day silo | 3.75 (top) | 1890 m ³ /m ² (top) | 640 | - |
| 8 | Bucket Elevator 3 | 0.75 | 0.45 | Storage silo | Day silo | 3.75 (bottom) | 1890 m ³ /m ² (top) | 640 | - |
| 9 | Vibratory screen | 2.4 | 1.2 | Front end | Rear end | 32 | 944 m ³ /m ² | 2720 | 14495 |
| 10 | Bucket Elevator 4 | | VS | Clean silo | 3.75(top) | | | 640 | - |
| 11 | Bucket Elevator 4 | | | | 3.75 (bottom) | | | 640 | - |
| Total | | | | | | | | 9837 | - |
| | | Total Volume to be extracted (with 10% safety margin) (m³/hr) = | | | | | | 10820 | 14495 |

The above table indicates that for Rice Mills like unit no. 1 (30 TPH paddy capacity), the dust shall be extracted from about 11 locations & total volume to be extracted is about 10820 m³/hr.

Against this requirement, in unit 1, actually the dust is extracted from only one location (instead of 11 locations) and that too 14495 m³/hr (against 2720 m³/hr required for that point), which is technically a wrong design issue & hence there are un-sucked fugitive emissions from various locations.

8.8 Typical Efficiencies of Various Control Systems for Various Particle Sizes:

Typical efficiency of various control devices for various size particles is given below:

Table: 8.8: Typical Collection Efficiencies of APCDs*

| Type of APCD | % Efficiency for fine particle size range in μ | | | % Efficiency for coarse particle size range in μ | | |
|--------------------------------------|--|----------------|---------------|--|----------------|-----------|
| | 0 to 2.5 μ | 2.5 to 6 μ | 6 to 10 μ | 10 to 20 μ | 20 to 30 μ | >30 μ |
| Gravity Collector (Settling Chamber) | 2.9 % | 4.0 % | 4.8 % | 7.4% | 15% | >40% |
| Single Cyclone | 10.0 % | 35.0 % | 50.0 % | 65% | 90% | >98% |

*Source: Environmental Pollution Control Engineering Book by C.S. Rao

8.9 Conclusions

- Most rice mills do have some dust extraction arrangement but requires modifications to make the system appropriate so as to cover dust extraction from belt conveyor transfer points, bucket elevator & screens, storage silo vents etc.
- There are substantial fugitive emissions from area like paddy unloading section, paddy cleaning section, milling section etc.
- There are substantial leakages of air in the dust extraction system from cyclone bottom opening, bag-filter casing, flanges and joints etc, which reduces the useful dust extraction volumes sucked by the induced draft fan.

UTILIZATION OF RICE HUSK ASH

9.1 A number of possible uses of Rice Husk Ash:

Typical possibilities of utilization of Rice Husk Boiler Ash that are being investigated are as shown below:

Table 9.1: Typical uses of rice husk ash and carbonize rice husk*

| | Rice husk ash (RHA) | Carbonized rice husk (CRH) |
|--------------------|---|---|
| Description | <ul style="list-style-type: none"> ➤ White, fine structure ➤ Contains around 80-90% silica around 25% of the weight of husk | <ul style="list-style-type: none"> ➤ Black, often still in the shape of the husk ➤ Depending on the combustion still contains 8-15% carbon |
| Use | <ul style="list-style-type: none"> • Partial cement replacement material for high-strength concrete • Steel additive for quality steel or tundish powder in steel production. • Used in manufacturing of refractory bricks • Insulators | <ul style="list-style-type: none"> ➤ Activated carbon ➤ Soil conditioner for poor soils ➤ Carbon sequestration, bio char ➤ Charcoal as fuel |

Source: International Rice Research Institute, Philippines (www.knowledgebank.irri.org)

Some of the Ash utilization Areas are elaborated below:

a) Use of Rice Husk Ash in Cement Concrete Mix as SILPOZZ*

The particle size of the cement is about 35 microns. There may be formation of void in the concrete mixes, if curing is not done properly. This reduces the strength and quality of the concrete. A product – Silpozz – which is made out of this RHA is finer than cement having particle size of 25 microns, so much so that it fills the interstices in between the cement in the aggregate, and that is why it can reduce the amount of cement in the concrete mix.

RHA is a good super-pozzolan. **Silpozz** can be used in a big way to make special concrete mixes. There is a growing demand for fine amorphous silica in the production of special cement and concrete mixes, high performance concrete, high strength, low permeability concrete, for use in bridges, marine environments, nuclear power plants etc. This market is currently filled by silica fume or micro silica, being imported from Norway, China and also from Burma. Due to limited supply of silica fumes in India and the demand being high the price of silica fume has risen.

- **Uses OF SILPOZZ:** Typical uses of SILPOZZ made from Rice Husk Boiler Ash are described below:

1) For Strength:

Silpozz has the potential to be used as a substitute silica fumes or micro silica at a much lower cost, without compromising on the quality aspect. Adding Silpozz to the concrete mix even in low replacement will enhance the workability, strength and impermeability of concrete mixes, while making the concrete durable to chemical attacks, abrasion and reinforcement corrosion.

2) For water proofing :

Silpozz has excellent water resistance (impermeability) properties and is used in waterproofing compounds to give better results. It reduces the water penetration by as much as 60%.

3) For Better Concrete in Marine environment:

Adding Silpozz to concrete and paints helps to reduce the chloride ion penetration by as much as 50 % into the structure, thus improving life of the building.

4) For Lower Heat of Hydration:

Adding Silpozz to concrete lowers the heat of hydration by as much as 30 % and prevents formation of cracks during casting.

TABLE 9.2: TECHNICAL SPECIFICATIONS OF SILPOZZ*

| | |
|---------------------------|--------------|
| SiO ₂ – Silica | 85 % minimum |
| Humidity | 2 % maximum |
| Particle size | 25 microns |
| Colour | Grey |
| Loss on ignition at 800°C | 4 % maximum |
| pH value | 8 |

*Source: www.ricehuskash.com/details.htm - N. Singhania, NK Enterprises, Orissa

9.2 Use of Rice Husk Ash in manufacturing Pozzolana Cement*

Pozzolanas are materials containing reactive silica and/or alumina which on their own have little or no binding property but, when mixed with lime in the presence of water, will set and harden like cement. Pozzolanas are an important ingredient in the production of alternative cementing materials to Portland cement (OPC). Alternative cements provide an excellent technical option to OPC at a much lower cost and have the potential to make a significant contribution towards the provision of low-cost building materials.

Pozzolanas can be used in combination with lime and/or OPC. When mixed with lime, pozzolanas will greatly improve the properties of lime-based mortars, concretes rendering it suitable for use in a wide range of building applications. They can be blended with OPC to improve the durability of concrete and its workability, and considerably reduce its cost.

RHA has been successfully used as a pozzolana in commercial production in a number of countries including Columbia, Thailand and India.

To produce the best pozzolanas, the burning of the husk must be carefully controlled to keep the temperature below 700°C and to ensure that the creation of carbon is kept to a minimum by supplying an adequate quantity of air. At burning temperatures below 700°C an ash rich in amorphous silica is formed which is highly reactive. Temperatures above 700°C produce a crystalline silica which is far less reactive. Ashes composed of crystalline silica will require a considerable amount of grinding to produce an acceptable reactivity. Even then they are unlikely to match the quality of amorphous ash.

The presence of large quantities of carbon in the ash will adversely affect the strength of any concrete or mortar produced using RHA cements. Where possible, the carbon content of the ash should be limited to a maximum of 10%, although some studies have suggested higher percentages can be tolerated with only a relatively small decrease in strength.

Rice husks which have been burnt in large open heaps to dispose of waste husks, or burnt as a fuel in an industrial furnace, are unlikely to produce ashes with the specification described above. In particular, they are likely to be crystalline due to high combustion temperatures. Although this does not rule out their use as a pozzolana, ashes composed of crystalline silica will require a considerable amount of grinding to produce an acceptable reactivity. Even then they are unlikely to match the quality of amorphous ash.

9.3 Grinding of Rice Husk Ash for use in Cement Production*

The second step in processing is grinding the RHA to a fine powder, and ball or hammer mills are usually used for this purpose. Crystalline ash is harder and will require more grinding in order to achieve the desired fineness. Fineness similar to or slightly greater than that of OPC is usually recommended for pozzolanas although some have been ground considerably finer. The minimum fineness recommended by the Indian Standards for pozzolana (1344) is 320 and 250m²/kg for grade 1 and 2 pozzolanas respectively, measured by the Blaine air permeability test. Although this standard is for calcined clay, the fineness requirements are also suitable for RHA.

- *Sources:
1. "Corrosion Performance of Rice Husk Ash Blended Concrete"- An article from 'Construction and Building Materials' August 1, 2007
 2. "Mortar Incorporating Rice Husk Ash- Strength and Porosity" – European Journal of Scientific Research ISSN 1450-216X Vol.40 No.3 (2010)
 3. www.ricehuskash.com

9.4 Utilization of Rice Husk Ash in Lime Stabilization of Poor Soils*

Many procedures have been developed to improve the physical behaviour of soil by incorporating a wide range of stabilizing agents, additives and conditioners. Undoubtedly the most widely applied methods involve the use of inorganic cementing agents. The effectiveness of such agents relies on the formation of cementing bonds between the particles in the soil system.

Soil stabilization has been widely recommended for developing countries for the construction of various elements of the pavements. The reasons usually put forward are that the use of locally available materials will lead to lower costs. An understanding of local conditions is of paramount importance while developing any soil stabilizing technique for a given country. Climatic conditions can affect the behaviour of stabilized soil materials as well as construction procedures.

Stabilization of soil by lime is achieved through cation exchange, flocculation and agglomeration, lime carbonation and pozzolanic reaction. These reactions involve interaction between soil silica and (or) alumina and lime to form various types of cementing agents thus enhancing the strength. The chemical processes modify the soil structure whereby larger grain aggregates are formed, leading to several advantage in the suitability of soil in road construction.

The characteristics of compacted soil, if improved, resulting from residue utilization like flyash, blast furnace slag, rice husk ash etc mostly brings environmental and economic benefits. However on a comparative scale the use of rice husk ash has found limited application.

Cumulative generation of ash requires a large space for disposal. Utilization of rice husk ash by exploiting its inherent properties is the only way to solve the environmental and disposal problem of the ash. A number of researchers have studied the physical and chemical properties of rice husk ash. Rice husk ash cannot be used alone for stabilization of soil because of the lack of cementitious properties. The high percentage of siliceous material in rice husk ash indicates that it has potential pozzolonic properties.

The properties of rice husk depend whether the husks have undergone complete destructive combustion or have been partially burnt. The rice husk ash has been classified into high carbon char, low carbon ash and carbon free ash.

Since RHA is much cheaper than lime, addition of rice husk ash in lime-soil mix can result in cost reduction of construction. In tropical countries where rice husks are abundant and considered as waste material, use of RHA in the construction of roads and other earthworks may particularly become attractive, because of reduced construction costs, reduced disposal costs and environmental damage and conservation of high grade construction materials.

*Source: "Effect of Rice Husk Ash on Lime Stabilization" – Published in *Journal of the Institute of Engineers (India)*, Volume 87, November 28, 2006

9.5 Other Uses of Rice Husk Ash:

RHA acts as a very good insulator. RHA is also used for insulation of molten metal in tundish and ladle in slab caster. The temperature of molten metal in the ladle is around 1400°C and above. When this metal flows from ladle to tundish, the temperature drops to around 1250°C . This reduction in temperature leads to choking and causes breakdown in the slab caster. When this RHA is spread as a coating over the molten metal in the tundish and in ladle, it acts as a very good insulator and the temperature is maintained, hence reducing the breakdown time of the casting.

As regards to the utilization aspects of Rice Husk Ash as discussed above, time tested examples of proven technologies could not be identified.

9.6 Some Definitions related to Rice Husk/Ash Utilization:

Amorphous Silica: Rice Husk is burnt in controlled temperature which is below 700°C . and the ash generated is amorphous in nature. The transformation of this amorphous state to crystalline state takes place if the ash is exposed to high temperatures above 850°C .

Green Concrete : Green Concrete as the name suggests is eco friendly and saves the environment by using waste products generated by industries in various forms like rice husk ash ,micro silica ,etc. to make resource-saving concrete structures .Use of green concrete helps in saving energy, emissions, waste water. Green concrete is often cheap to produce as it uses waste products directly as a partial substitute for cement, thus saving energy consumption in production of cement. Over and above green concrete has greater strength and durability than the normal concrete.

Silica Fumes: Silica Fumes (very fine non crystalline silicon dioxide) or Micro silica is a waste product of induction arc furnace in the ferro silicon industry.

9.7 Possible Alternate Uses of Rice Husk than as Boiler Fuel:-

Rice Husk can be put to use as building material, fertilizer, insulation material, or fuel. Some of the current and potential applications are listed below apart from being utilized as a fuel:

1) Chemistry:

Rice husk can be used to produce mesoporous molecular sieves , which are applied as catalysts for various chemical reactions, as a support for drug delivery system and as adsorbent in waste water treatment.

2) Building material:

Rice husks are a class A insulating material because they are difficult to burn and less likely to allow moisture to propagate mold or fungi. Rice husk when burned produces silica which provides excellent thermal insulation.

3) Fertilizer:

Rice husks are organic material and can be composted. However, their high lignin content can make the process slow. Sometimes earthworms are used to accelerate the process. Using vermicomposting techniques, the husks can be converted to fertilizer in about four months.

- 4) SiC Production:** Rice husks are a low-cost material from which silicon carbide “whiskers” can be manufactured. The SiC whiskers are then used to reinforce ceramic cutting tools, increasing their strength tenfold.
- 5) Juice extraction:** Rice hulls are used as a “press aid” to improve extraction efficiency of apple pressing.
- 6) Pillow stuffing:** Rice hulls are used as pillow stuffing. The pillows are loosely stuffed and considered therapeutic as they retain the shape of the head. Since 2009, in China, these pillows have become popular, and are considered a luxury item.
- 7) Animal Fodder:** Rice husk is an inexpensive byproduct of human food processing, serving as a source of fiber that is considered a filler ingredient in cheap pet foods.

PROPOSED GUIDELINES & SITING CRITERIA FOR RICE MILLS

10.1 Guidelines for Handling, Storage & Transport of Rice Husk

i Prevention of Fine Dust from various operations of paddy processing

- a) The industry shall ensure the adequate dust extraction form various points of dust generation starting from unloading section up to paddy cleaning section as mentioned below.
- At the point of discharge from the belt conveyor (from paddy unloading area) to bucket elevator.
 - Extraction from the bucket elevator from two locations, one at the bottom end (above the bottom roller), and the other at the top side of the elevator (just below the top roller)
 - Extraction from the silo top vent, near the point of fall of paddy into the silo.
 - Extraction from the top of the cleaning screen (vibratory or rotary screen)
 - As the dust particles extracted from the paddy are very fine in size (majority of the particles being less than 10 micron size), the extracted dust should be filtered through a bag filter type control device. A low cost bag filter made from cotton bags with a manual shaker type cleaning arrangement could be installed. The fine dust filtered should be collected in bags and sealed and then disposed along with the bag, so that the fine dust does not get airborne again due to secondary wind blowing etc.

The unit may refer the Foot Note for designing of dust extraction systems for them.

Foot Note: Reference Design Criteria for Dust Extraction Volumes

- *For extraction of dust from the transfer point of a belt conveyor, about 1968 m³/hr/m (600 m³/hr/ft) of belt width (for belt speed of less than 1 m /Sec.) Or 2789 m³/hr/m (850 m³/hr/ft) of belt width for belt speed more than 1 m/sec shall be extracted.*
- *For bucket elevator extraction, 1830 m³/m² (170 m³/ sq. ft) of casing cross section each shall be extracted from two locations, one at the bottom end and other at the top end of the elevator.*
- *For cylindrical or vibratory cleaning screens, 1830 m³/m² (170 m³/ sq. ft) of cross section of screen shall be extracted.*

b) Prevention of dust during blowing, storage and handling of husk:

- The units shall provide a closed room type enclosure for blowing & storage of rice husk. This room type enclosure shall be closed from all sides and have an access door for loading/handling of rice husk. A vent above roof level shall be provided on this enclosure connected to a bag-filter to arrest/filter the fine particles. No activity regarding blowing & storage of rice husk shall be carried out outside the said enclosure.
- The units should have a minimum area for closed storage of rice husk in the plant premises. The units may decide the size of the enclosure based on their milling capacity, operating hours and utilization of husk. Typically one ton of paddy processing generates about 220 kg of husk, which would occupy 2 to 2.5 m³ storage volume, as the bulk density of husk is in the range of 70-110 kg/m³.

c) Prevention of dust form rice polishing section:

- The rice bran generated during polishing of raw rice, is fine in size and can get airborne with wind, and should be stored in “closed sheds only”. The fine particles escaping from the air vent shall be connected to a filter bag arrangement to ensure that only clean air is released to the atmosphere.

ii. Prevention of Fine Dust emissions during conveyance/Transportation of husk

- All the belt/chain conveyors conveying husk from de-husking section to storage and from storage to boiler section, shall be covered from all sides to prevent wind blowing of the husk.
- During transporting husk through vehicles, it should be covered from all sides with tarpoline to prevent wind blowing of husk.
- All the rice mills shall provide paved/brick roads inside their premises for movement of vehicles so as to prevent dust generation.

10.2 Guidelines for Handling, Transportation, Storage and Disposal of Ash from Husk Fired Boiler

- A
1. The ash collected from APCD from husk fired boiler shall be temporarily stored in a shed / chamber closed from at least three sides and a roof, with access only from the front side for ash removal purpose.
 2. During loading/unloading of ash, water shall be spread periodically to keep the ash heap in wet condition so that the top layer remains wet thereby prevent blowing of ash particles due to wind.
 3. All the conveyors/vehicles conveying ash within or outside the plant premises shall be covered from all sides to prevent blowing of ash particles due to wind.
 4. The boiler ash shall be disposed in such a way that secondary emissions of the ash do not occur due to wind blowing effect. The following disposal practices may be followed:

- (a) For units disposing ash outside their own premises:
- The rice mills disposing their boiler ash outside their premises through contractors shall ensure that the ash has been disposed to a designated landfill site facility as approved by State Pollution Control Board.
- (b) For units disposing ash within their own premises:
- The units disposing ash at the ground level should cover the ash with soil and periodically spray water on the disposed ash so as to keep it in wet condition. Piling up of another batch of ash over the earlier disposed ash could be done, but the ash heap needs to be covered each time by soil and kept wet by spraying water. A wind breaking wall of a height equal to the height of the ash heap disposed shall be erected around the ash disposal site, leaving the opening only for access road.
 - The industry may develop underground ditch for disposal of boiler ash within plant premises.
- B** The industry should explore possibilities of ash utilization in making bricks or use in cement plants instead of disposal. To enable possibility of use of ash in cement plants, controlled burning of rice husk in the boiler shall be adopted through use of preferably fluidized bed boiler such that unburnt carbon in ash is below 8 percent. The feasibility to be explored by concerned agencies.

10.3 Siting Criteria for Rice Mills:

- The Siting of the Rice Mills shall not be less than 1 Km from the Census village and notified Authorized area.
- The minimum distance between the boundary of the new rice mill site and right of way of the
 - i) National Highway shall be - 100 m
 - ii) State Highway shall be - 50 m
 - iii) Village roads shall be - 25 m
- The industry should plant thick plantation of spreading crown trees all along the boundary wall of the plant. For large rice mills (processing more than 20 ton/hr paddy), a Green belt of 3 m width shall be developed. For other rice mills, at least 2 rows of trees shall be developed along the boundary wall of plants.

List of Rice Mills visited for the Study

| S.No. | Name of the Unit | Address | Scale of Operation | Milling Capacity | Type of Rice produced |
|-------|--------------------|--|--------------------|------------------|-----------------------------------|
| 1. | KRBL Limited | Village Bhasaur, Dhuri, Sangrur, Punjab. | Large | 55 tonne/hr | Parboiled Rice & White (Raw) Rice |
| 2. | J.S. Rice Mills | Memasa Village, Dhuri, Punjab | Small | 3 tonne/hr | White (Raw) Rice Mill |
| 3. | J.P. Rice Traders | Village Bhasaur, Dhuri, Punjab | Small | 1 tonne/hr | White (Raw) Rice Mill |
| 4. | D.D. International | Village Takhana, Taraori Distt., Karnal | Medium | 12 tonne/hr | Parboiled Rice & White (Raw) Rice |
| 5. | Garg Enterprises | Village Takhana, Taraori Distt., Karnal | Small | 2 tonne/hr | Parboiled Rice |
| 6. | Bombay Agro Tech. | Bhullerheri, Dhuri, Sangrur, Punjab | Small | 5 tonne/hr | White (Raw) Rice |
| 7. | BCB Agro Tech. | Bhullerheri, Dhuri, Sangrur, Punjab | Small | 2 tonne/ hr | White (Raw) Rice |
| 8. | Veejay Rice Mills | Kerala | Small | 1.16 tonne/hr | Parboiled Rice |
| 9. | KKR Rice Mills | Kerala | Small | 2 tonne/hr | Parboiled |
| 10 | Edathala Modern | Kerala | Small | 1.16 tonne/hr | Parboiled |
| 11 | K &T | Kerala | Small | 2 tonne/hr | Parboiled |

Copy of Rice Mills Questionnaire for Preliminary visits

1. Name of the Unit :

2. Contact Details of the Unit Head:

| | |
|---------------|--------------|
| Name: | Designation: |
| Address:City: | State: |
| Telephone: | E-mail: |
| Fax: | Website: |

3. Scale of Operation: Large Medium Small Tiny

4. Location of plant: Residential/ Industrial/Other

*Approximate distance from residential area:

5. Milling capacity in metric tonne *:

6. a) Year of commission:

b) No. of months of operation:

Please specify all the months:

7. Type of mill: Dry Rice grinding mill / Parboiled mill / White (Raw) rice mill

8. Raw material : (tick the appropriate one)

| | | | |
|-----------------------------|--------------------------|----------------|--------------------------|
| Paddy | <input type="checkbox"/> | Milled rice | <input type="checkbox"/> |
| Brown rice | <input type="checkbox"/> | Parboiled rice | <input type="checkbox"/> |
| Any other , please specify* | | | |

9. Storage & Capacity: Silo Godown/bulk Godown/bags

10. Quality of raw material:

➤ Average Moisture Content (%):

➤ Field dried

Mechanically dried

11. Brief Process Description & Process Flow Chart.

12. Please specify type of technologies used in your plant for the following operations: (whichever applicable)

Cleaning of paddy/Parboiling section/Hulling / Dehusking operation/Husk separation /Whitening and polishing operation

13. Particulars of by- products:

a) Rice Bran for: (tick the appropriate one)

| | | | |
|------------|-------------------|---------|-----------|
| Feed stuff | Extraction plants | Exports | Any other |
|------------|-------------------|---------|-----------|

b) Rice Husk for: (tick the appropriate one)

| | | | | |
|--------|-------|---------------|-------------|---------------|
| Boiler | Waste | Milling Plant | Cattle feed | Any other use |
|--------|-------|---------------|-------------|---------------|

➤ Storage facilities: Required Available

➤ Type of Storage:

➤ Holding Capacity: Tonne sq.m / sq.ft

c) Boiler Ash:

➤ Storage facilities: Required Available

➤ Type of Storage:

➤ Mode of Disposal:

14. Boiler section details: Efficiency/No. of chimney/Chimney height & diameter

15. Details of Fuel Consumption: (if applicable)

| Types of Fuel used | Average Quantity consumed per day |
|-------------------------|-----------------------------------|
| Rice husk | |
| Coal | |
| Others (please specify) | |

16. APCD's at Sources of Dust Emissions: (whichever applicable)

| S.No. | Sources of emission | Type of APCD employed | ID Fan Capacity |
|-------|---------------------------------|-----------------------|-----------------|
| 1. | Paddy pre-cleaner | | |
| 2. | Paddy cleaner/ Vibratory screen | | |
| 3. | De-stoner machine | | |
| 4. | De-husker | | |
| 5. | Paddy separator | | |
| 6. | Boiler House | | |

17. Characterization and Quantification of pollutants:

| Milling section | Average Dust concentration | | Type of APCD | Gas flow Nm ³ /hr | Average Dust load before APCD (kg/hr) | Specific Dust load before APCD (kg/T) |
|-------------------------|---------------------------------|--------------------------------|--------------|------------------------------|---------------------------------------|---------------------------------------|
| | Before APCD* mg/Nm ³ | After APCD* mg/Nm ³ | | | | |
| a. Cleaning section | | | | | | |
| b. Milling section | | | | | | |
| c. Boiler House section | | | | | | |

*Data Sheet of Traverse Points Standard Protocol***TRAVERSE POINTS STANDARD PROTOCOL:**

| Traverse Point | Traverse points in Circular Stack or Ducts | | | | | | |
|----------------|--|------|------|------|------|------|------|
| | | | | | | | |
| 1 | 4 | 6 | 8 | 10 | 12 | 14 | 16 |
| 2 | 6.7 | 4.4 | 3.2 | 2.6 | 2.1 | 1.8 | 1.6 |
| 3 | 25 | 14.6 | 10.5 | 8.2 | 6.7 | 5.7 | 4.9 |
| 4 | 75 | 29.6 | 19.4 | 14.6 | 11.8 | 9.9 | 8.5 |
| 5 | 73.3 | 70.4 | 32.3 | 22.6 | 17.7 | 14.6 | 12.5 |
| 6 | | 85.4 | 67.7 | 34.2 | 25.0 | 20.1 | 16.9 |
| 7 | | 95.6 | 80.6 | 65.8 | 35.6 | 26.9 | 22 |
| 8 | | | 89.5 | 77.4 | 64.4 | 36.6 | 28.3 |
| 9 | | | 96.8 | 85.4 | 75.0 | 63.4 | 37.5 |
| 10 | | | | 91.8 | 82.3 | 73.1 | 62.5 |
| 11 | | | | 97.4 | 88.2 | 74.9 | 71.7 |
| 12 | | | | | 93.3 | 85.4 | 78 |
| 13 | | | | | 97.9 | 90.1 | 83.1 |
| 14 | | | | | | 94.3 | 87.5 |
| 15 | | | | | | 98.2 | 91.5 |
| 16 | | | | | | | 95.1 |
| 17 | | | | | | | 98.4 |

Data sheet for point source emission monitoring

| | |
|-------------------|-------------|
| Location: | Fuel Used: |
| Fuel Consumption: | Plant Load: |

Physical Details of Stack:

- Height:
- Diameter (m):
- Cross Sectional Area (m²):
- Flue Gas temperature, °K (Ts): =
- Ambient Temperature, °K (Ta): =
- Atmospheric Pressure, mm Hg (Pa):
- Static Pressure, mm Hg (Pst):
- Absolute Stack Pressure, mm Hg (Ps): Pa + Pst =

| Traverse Points | T1 | T2 | T3 | T4 | T5 |
|---|----|----|----|----|----|
| Distance from the inside wall of the Stack Duct (cms) | | | | | |
| Pressure Drop (mm) | | | | | |
| Velocity (m/sec) | | | | | |

- Average Velocity , m/s =
- Flow (m³/sec) =
- Flow (Nm³/ sec) =

Literature Data on % of fines in Dust in Grain Mills

Literature Survey on percentage of particles in various size ranges in the dust from grain handling and processing mills is reproduced below. In developed countries, all the food grains like wheat, paddy, pea etc are classified as “grains”. The typical particle size distribution of grain handling/processing operations is given in table 8.1, which can be considered representation for either of the grains handled.

Typical PSD for Grain Handling/Processing Operations

| Operation | Sub-section | Emission generated due to | Typical equipments | Percentage of Particle Size Range (microns) | | | Overall % < 10 micron |
|------------|-----------------------------------|-----------------------------------|---|---|-------|------|-----------------------|
| | | | | 0-2.5 | 2.5-6 | 6-10 | |
| Handling | Material Transfer, Misc. handling | Mechanical agitation of materials | Bucket elevators, unloading etc. | 1% | 6% | 8% | 15 % |
| Processing | Screening, Grinding | Separation size reduction | Rotary / Vibratory screens, Grinding machines | 23% | 20% | 18% | 61 % |

Ref: Air Pollution Engineering Manual, USA.

Reference Papers from Handbook

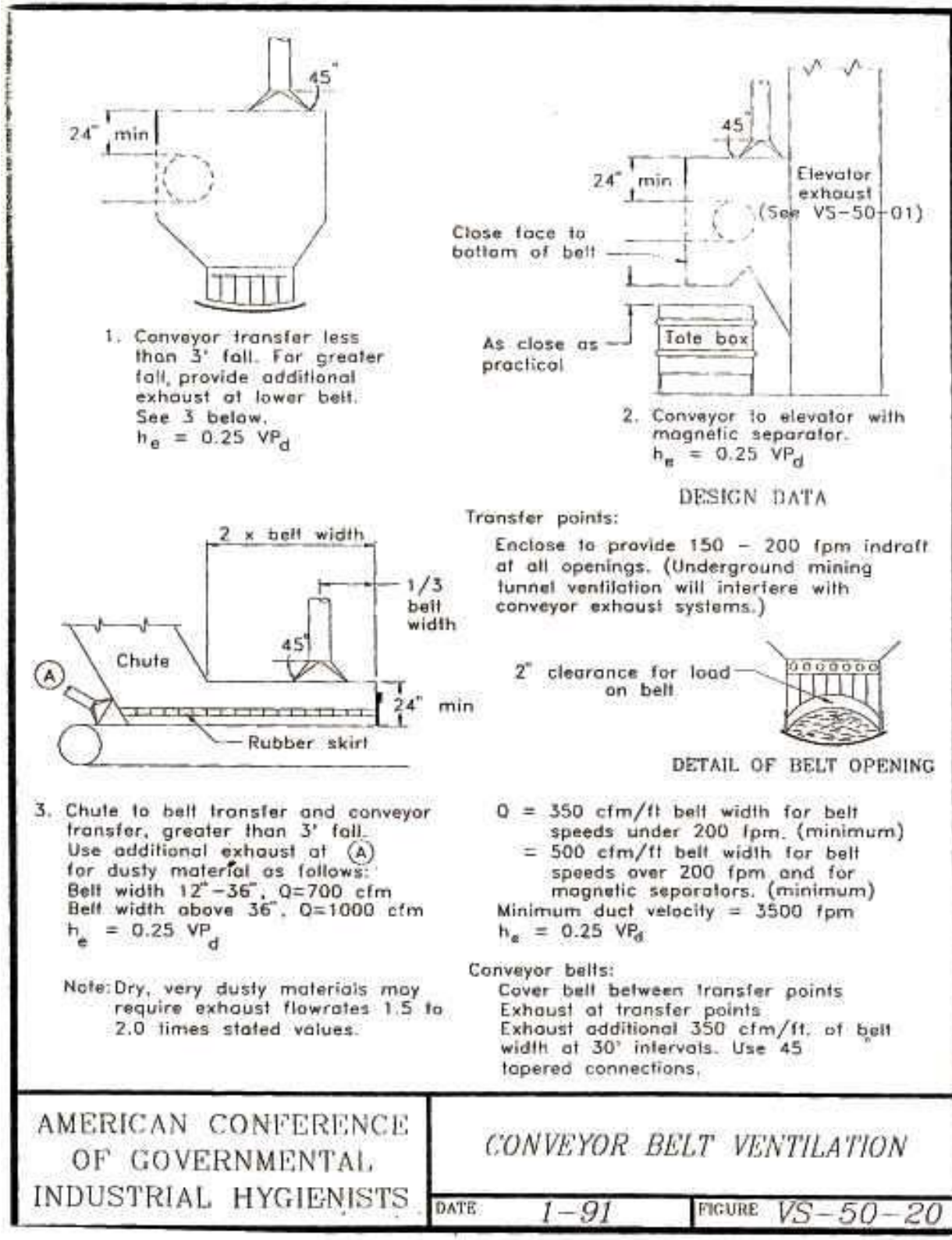

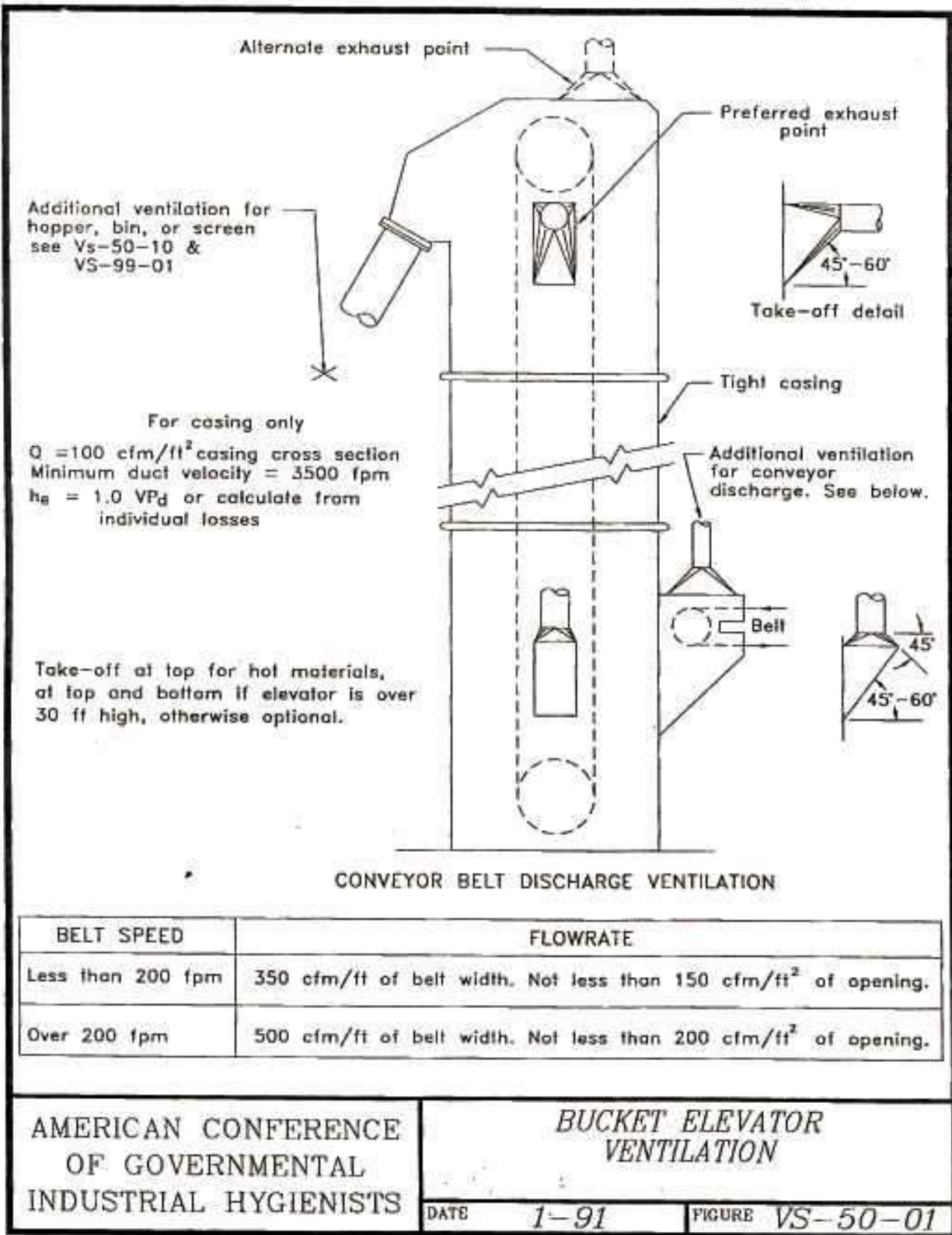

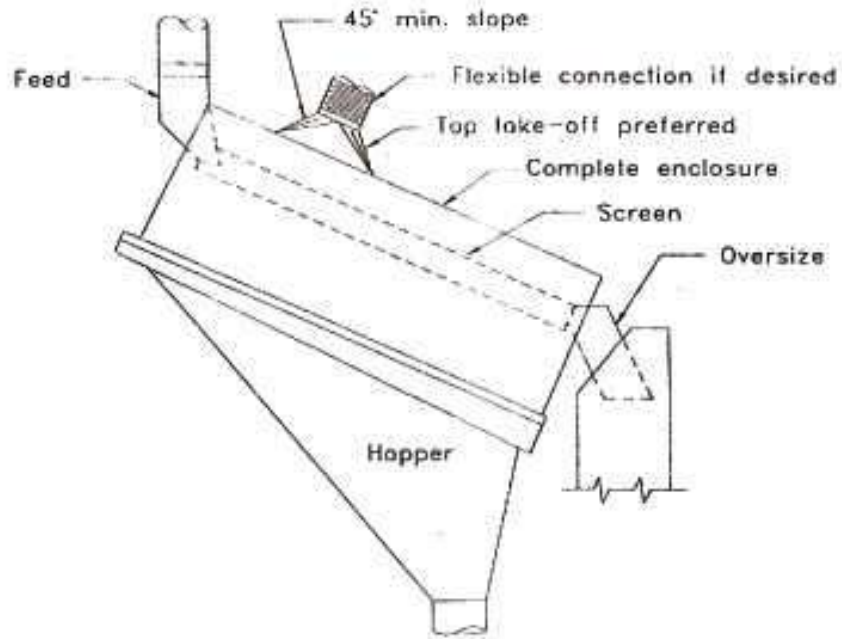

FLAT DECK SCREEN

$Q = 200 \text{ cfm/ft}^2$ through hood openings, but not less than 50 cfm/ft^2 screen area. No increase for multiple decks
 Minimum duct velocity = 3500 fpm
 $h_e = 0.50 V_p^2$

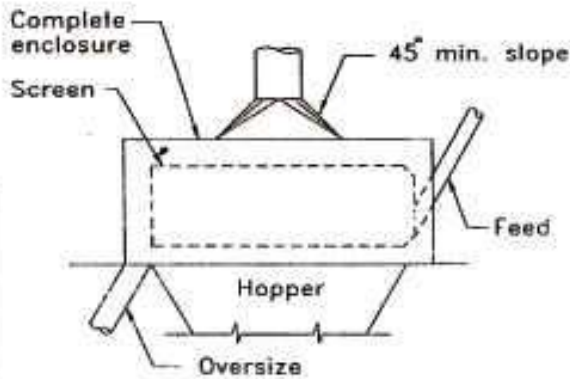

CYLINDRICAL SCREEN

$Q = 100 \text{ cfm/ft}^2$ circular cross section of screen; at least 400 cfm/ft^2 of enclosure opening
 Minimum duct velocity = 3500 fpm
 $h_e = 0.50 V_p^2$

AMERICAN CONFERENCE
 OF GOVERNMENTAL
 INDUSTRIAL HYGIENISTS

SCREENS

DATE 12-90

FIGURE VS-99-01

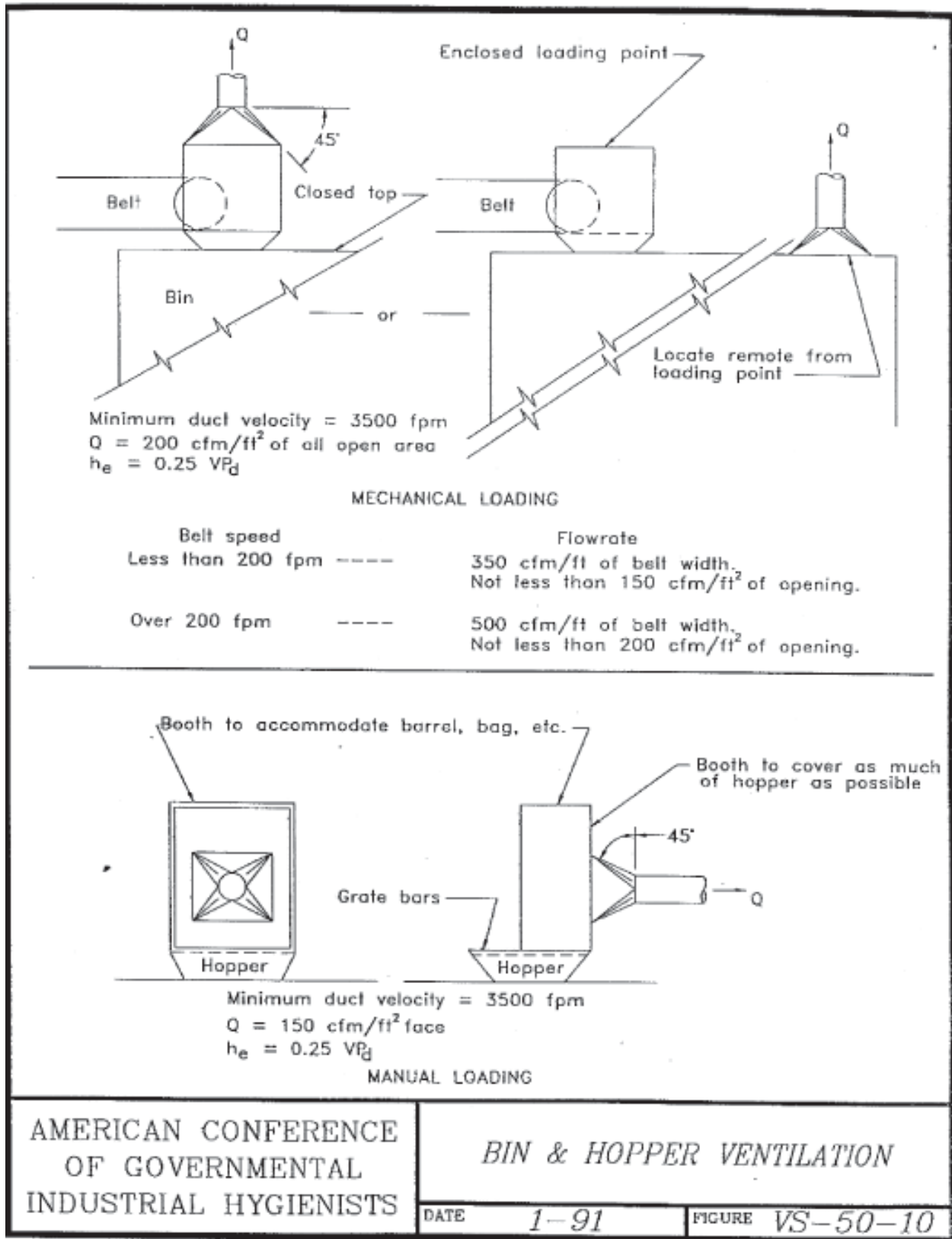

341

Bibliography

- *Stack Monitoring: Report on Material And Methodology For Isokinetic Sampling, 2010* ([www.cpcb.nic.in/oldwebsite/NewItem/StandardoperatingProcedures\(SOPs\)/Chapter_1.pdf](http://www.cpcb.nic.in/oldwebsite/NewItem/StandardoperatingProcedures(SOPs)/Chapter_1.pdf))
- *Comprehensive Industry Document on Pulse, Wheat and Rice Mills- A Central Pollution Control Board publication, COINDS 2008*
- *Waste Minimization in Parboiled Rice Mill Units – Andhra Pradesh Pollution Control Board Publication, April 2005.* (www.appcb.ap.nic.in/cpc/Bulletin_123_Parboiled_final.pdf)
- *Respirable Dust Sampler Operational Manual, Envirotech, Okhla Industrial Area, New Delhi, 2008*
- *Abu Bakar B.H. Malaysian Rice Husk Ash – Improving the Durability and Corrosion Resistance of Concrete: Pre-review School of Civil Engineering, Engineering Campus, 14300 Nibong Tebal, Pulau Pinang, Universiy Sains Malaysia, MALAYSIA Vol. 1 (1) – March 2010*
- *Envirotech Stack Sampler Operational Manual VSS1, 2008*
- *Muntohar A.S. Utilization of Uncontrolled Burnt Rice Husk Ash in Soil Improvement, Dept. of Civil and Environmental Engineering, University of Malaya, Malaysia, September 2002*
- *PGL de Padua, Concretes Made With Rice Husk Ash Obtained At Low Temperature, Proceedings of the 11th International Conference on Non-conventional Materials and Technologies (NOCMAT), 2009*
- *Rashid M.H. Mortar Incorporating Rice Husk Ash: Strength and Porosity. (European Journal of Scientific Research, Vol.40 No.3 (2010), pp.471-477, 2010* (<http://www.eurojournals.com/ejsr.htm>)
- *Subbukrishna D.N. Precipitated Silica from Rice Husk Ash By IPSIT Process, Indian Institute of Science Precipitated Silica Technology, Bangalore, India, May 2007*
- *Jha J.N. Effect of Rice Husk Ash on Lime Stabilization, Published In Journal of The Institution Of Engineers (India), Volume 87, November 28, 2006.*
- *Sustainable Building Design Manual: Sustainable building design practices, Energy and Resources Institute (New Delhi), 2004*
- *Goodfellow Howard, Industrial Ventilation Design Guidebook, University of Toronto, Canada, 2005*
- *Rice Milling Manual- International Rice and Research Institute, Manila, Phillipines, 2006*

- Rao C.S., *Environmental Pollution Control Engineering Book*, **2002**
- Nayak Purusottam, *Problems and Prospects of Rice Mill Modernization (Journal of Assam University, Vol.-1, No.1, pp. 22-28, 1996*
- Amutha K., *Extraction, Synthesis And Characterization Of Nanosilica From Rice Husk Ash, International Journal of Nanotechnology and Applications Volume 4, pp. 61-66, 2010.*
- Naji Givi, et al, *Contribution of Rice Husk Ash to the Properties of Mortar and Concrete: A Review, Journal of American Science, 2010* (www.americanscience.org/journals/amsci/am0603/21_2167_Review_am0603_157_165.pdf)
- Jittima Prasara, *Comparative Life Cycle Assessment of Rice Husk Utilization in Thailand- A thesis report, RMIT University, August 2009*
- Joshi R.C., Lohtia.R.P. *Flyash in Concrete – Production, Properties and Uses- Advances in Concrete Technology, Volume 2, 1997*
- *Waste Ash Pozzolans- Reactivity and Suitability for Use in Concrete,*
- GaryM. Hutter, *Reference Data Sheet of Air Pollution Control Devices, May 1997*
- *Rice Milling Process* (www.youtube.com/watch?v=TfD5Uhg3JHo)
- *Use of Rice Husks as Fuel in Process Steam Boilers (Asia-Pacific Environmental Innovation Strategies (APEIS), 2009* (enviroscope.iges.or.jp/contents/APEIS/RISPO/inventory/db/pdf/0004.pdf)
- *Industrial Ventilation- a manual of recommended practices, 23rd edition, American Conference of Governmental Industrial hygienists, USA, 1998*
- *Cyclonic Separation* (en.wikipedia.org/wiki/Cyclonic_separation)- *Description of operation of various Air Pollution Control Devices*
- *Rice Husk, Rice Knowledge Bank Website* (www.knowledgebank.irri.org/rkb/index.php/rice-milling/byproducts-and-their-utilization/rice-husk)
- Mittal D. *Silica from Ash- A Valuable Product from Waste Material, RESONANCE July 1997* (www.ias.ac.in/resonance/July1997/pdf/July1997p64-66.pdf)
- D.N. Subbukrishna, K.C. Suresh, P.J.Paul, S. Dasappa and N.K.S. Rajan – “Precipitated Silica from Rice Husk Ash by IPSIT Process” (*Combustion, Gasification & Propulsion Laboratory, IISc, Bengaluru*).15th European Biomass Conference and Exhibition, May 2007.



CENTRAL POLLUTION CONTROL BOARD
MINISTRY OF ENVIRONMENT & FORESTS
Government of India, New Delhi
Website: www.cpcb.nic.in